OWNER'S MANUAL

16 BIT DIGITAL
PERCUSSION SYNTHESIZER

XD-5

KAWAI

NOTE: This equipment has been tested and found to comply with the limits for a Class B digital device, pursuant to Part 15 of the FCC Rules. These limits are designed to provide reasonable protection against harmful interference in a residential installation. This equipment generates, uses and can radiate radio frequency energy and, if not installed and used in accordance with the instructions, may cause harmful interference to radio communications. However, there is no guarantee that interference will not occur in a particular installation. If this equipment does cause harmful interference to radio or television reception, which can be determined by turning the equipment off and on, the user is encouraged to try to correct the interference by one or more of the following measures:

- Reorient or relocate the receiving antenna.
- Increase the separation between the equipment and receiver.
- Connect the equipment into an outlet on a circuit different from that to which the receiver is connected.
- Consult the dealer or an experienced radio/TV technician for help.

This digital apparatus does not exceed the Class B limits for radio noise emissions from digital apparatus set out in the Radio Interference Regulations of the Canadian Department of Communications.

■ Care and Maintenance

• Proper Care

Your XD-5 synthesizer is a delicate musical instrument. To prevent breakdowns and ensure years of reliable, trouble-free service, shield it from:

- Direct sunlight and exposure to the elements
- Extremes in temperature or humidity
- Dusty environments
- Vibration – especially during transport

• Power Supply

- Use only the AC adaptor shipped with the XD-5 and connect it only to a power supply with a voltage within the limits stated on the ratings plate on the back.
- Make sure that all power switches are off before changing equipment connections.
- Check all equipment connections before applying the power.
- Do not connect to the same circuit as a heavy load or equipment that generates line noise.

• Line Noise Reset

- The high-speed microprocessor at the core of the XD-5 is extremely sensitive to line noise and sudden fluctuations in the supply voltage. Should it "lock up" under such conditions, simply turn it off for a few seconds and then reapply the power.

• Cleaning

- Clean the instrument with a soft cloth, a mild detergent, and lukewarm water.
- Never use harsh or abrasive cleansers or organic solvents.

• Battery Backup

- The lithium battery that protects the memory contents while the power to the unit is off is good for more than five years of normal use. We recommend, however, that you have your nearest authorized service representative replace it promptly after five years.

• Repairs

- Always save the INTERNAL tone patches to a memory card before taking the unit in for repairs or servicing. Otherwise, they may be lost in the course of testing.

• Memory Cards

- The XD-5 uses Kawai DC-16 memory cards for external data storage. These cards are available from your nearest authorized Kawai dealer.

XD-5 Panel Layout

[FRONT VIEW]

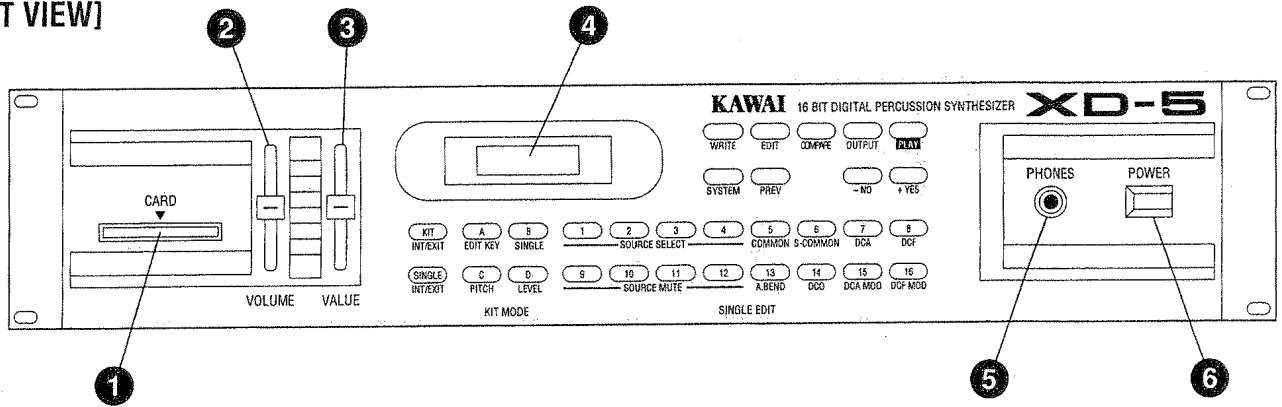

[REAR VIEW]

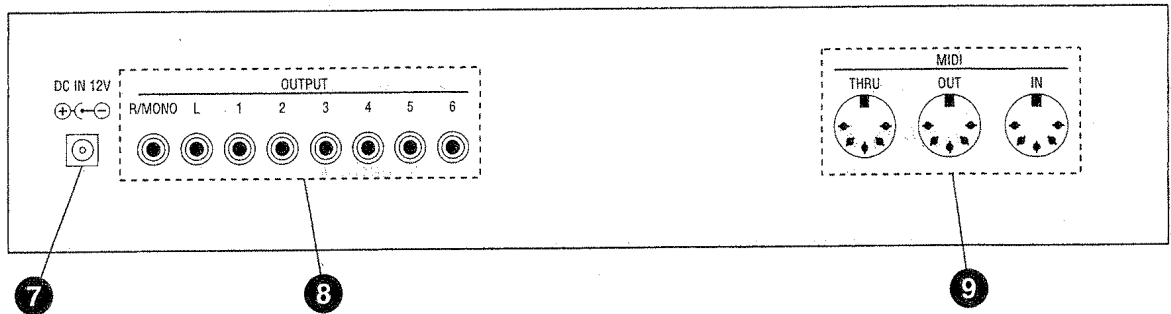

[CONTROL SWITCHES]

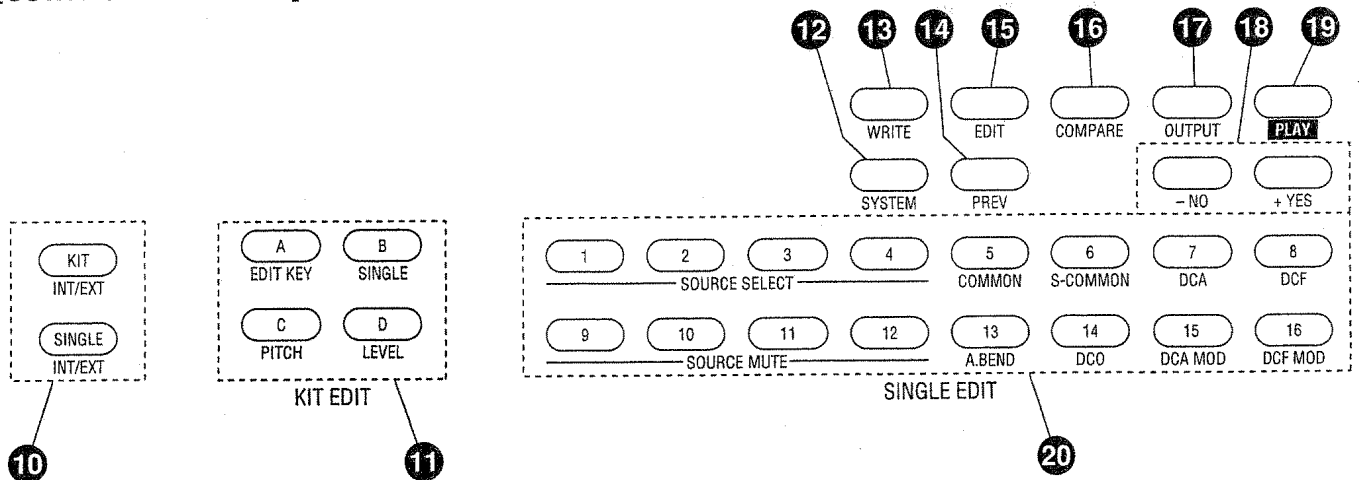

■ Names of Parts

- 1. Card slot**
The card slot is for the insertion of (optional) memory cards (DC-16). The ▼ mark on the card should be aligned with the mark ▽ on the unit when inserting.
- 2. VOLUME slider**
Used to adjust the sound output from the headphone and output (R/MONO, L) jacks.
- 3. VALUE slider**
Used to make major changes to parameter values during editing.
- 4. DISPLAY**
Indicates the patch number and name while playing, and the value of the parameter during editing.
- 5. PHONES jack**
The stereo headphone jack is used to monitor the sound of R/MONO & L output. (See P. 42)
- 6. POWER switch**
Turns the instrument's power on and off.
- 7. DC IN jack**
This jack is used to connect the external power supply.
- 8. Output jacks**
The output jacks are used to connect the unit to a keyboard amplifier or PA equipment. The XD-5 has individual outputs 1 ~ 6 (separate outputs) in addition to the L and R/MONO jacks.
- 9. MIDI (IN, OUT, THRU) jacks**
These are used to connect equipment to other MIDI devices.
- 10. Patch select switch group 1 (KIT, SINGLE)**
Selects between SINGLE and KIT PLAY modes when selecting patches, and between internal tones and those stored on a card.
- 11. Patch select switch group 2 (A, B, C, D)**
Selects between the four banks, A, B, C and D, when selecting SINGLE patches, and selects parameters when editing tones in KIT EDIT mode.
- 12. SYSTEM switch**
Used to change SYSTEM Settings (e.g. tuning, GATE MODE) and MIDI parameters.
- 13. WRITE switch**
Used to store changed tone data into memory as well as for MIDI DATA DUMP and to SAVE and LOAD data from a card.
- 14. PREV switch**
Calls up the previously edited parameter during an editing session.
- 15. EDIT switch**
Puts the XD-5 into the EDIT mode to allow tones to be modified.
- 16. COMPARE switch**
Used to compare the edited tone values with the values before editing.
- 17. OUTPUT switch**
Used for editing OUTPUT patches.
- 18. VALUE switches**
Change the values of parameters during editing.
- 19. PLAY switch**
Used to hear the currently selected sound. In SINGLE mode, you will hear C3 note by pressing this switch. In KIT mode, you will hear the currently (or last) editing sound.
- 20. Patch select switch group 3 (1-16)**
Selects among the 16 patch numbers. During SINGLE editing, it may be used to select the Source Mute, Source Select, Parameter Select.

Introduction

Thank you for purchasing the Kawai XD-5 16 bit digital percussion synthesizer.

This revolutionary new synthesizer uses 16-bit 44.1 kHz sampled and synthesized waveforms for optimum sound quality. The friendly user-interface and parameter structure of the Kawai K series has been retained, and new functions and features added to increase the XD-5's music making power.

Please read this manual thoroughly before using the XD-5. It has been written to allow you to get the most out of the instrument's capabilities with the least amount of effort.

■ Features

The XD-5 is a rack-mount digital percussion synthesizer equipped with a DMS (Digital Multi Spectrum) tone generator capable of up to 16 notes of polyphony when set at two Sources per tone.

The XD-5 utilizes a newly developed DMS tone generator. Not only does it use 16 bit system, but because it has a Digital Filter function, your freedom in producing sounds is unlimited. It is also capable of AM (Ring Modulation) to easily and simply produce clangorous and distorted sounds.

- **256 high quality internal waveforms**

The XD-5 has 41 DC (Digital Cyclic) waveforms composed of as many as 128 harmonics, and a total of 215 PCM waveforms, for a total of 256 waveforms. Because the XD-5's internal waveforms are reproduced using 16-bit 44.1 kHz quantization, noise and distortion are virtually inaudible.

- **INDIVIDUAL OUTPUT function**

The XD-5 is equipped not only with two stereo output jacks, but with six separate output jacks as well to allow the connection of external effects units to create high quality sound.

- **GATE MODE**

When you use the pad controller or drum machine which has no GATE parameter, you can play full cycle of envelope by using this mode.

- **Card**

A card permits an increased number of tones to be placed in memory. One card can hold 64 SINGLE Patches, 16 KIT Patches and 16 OUTPUT Patches.

Panel Nomenclature

SINGLE/KIT PLAY Mode

- KIT** / INT/EXT : Select Internal or Card KIT Patch (P. 9)
- SINGLE** / INT/EXT : Select Internal or Card SINGLE Patch (P. 10)

KIT EDIT Mode

- EDIT** : Enter EDIT mode (P. 14)
- +YES** / **-NO** : Select Value (P. 14)
- PREV** : Return to Previous Parameter (P. 14)
- COMPARE** : Compare with Sound before Editing (P. 14)
- WRITE** : Perform WRITE, followed by SAVE and LOAD
- A** / **EDIT KEY** : Select EDIT KEY (P. 18)
- B** / **SINGLE** : Select Instrument (SINGLE) (P. 18)
- C** / **PITCH** : Set the pitch of instrument (SINGLE) (P. 19)
- D** / **LEVEL** : Set Instrument Level and Output Destination (P. 20)

SINGLE EDIT Mode

- 1** / **2** / **3** / **4** / **SOURCE SELECT** : Select EDIT Source (P. 27)
- 9** / **10** / **11** / **12** / **SOURCE MUTE** : Select Source Mute (P. 27)
- 5** / **COMMON** : Select Source mode, AM, POLY mode (P. 29, 30)
- 6** / **S-COMMON** : Set Delay, Velocity Curve (P. 32)
- 7** / **DCA** : Set Volume Envelope (P. 34)
- 8** / **DCF** : Set Cutoff, Resonance, etc. (P. 37)
- 13** / **A.BEND** : Set Auto Bend (P. 31)
- 14** / **DCO** : Set Waveform and Pitch (P. 33)
- 15** / **DCA MOD** : Control Volume with Velocity (P. 35)
- 16** / **DCF MOD** : Change Tone in real time (P. 38)

Other EDIT Mode

- OUTPUT** : Set Panpot or Individual Output (P. 42~44)
- PLAY** : Check the currently selected sound (P. 2)
- SYSTEM** : Set Tuning, GATE MODE and MIDI (P. 45~48)
- WRITE** : Set MIDI Data Dump contents and Execute Dump (P. 50)

LET'S PLAY!

KIT EDIT

SINGLE EDIT

OUTPUT EDIT

SYSTEM SETTING

ADVANCED USER

OPTION DATA

■ XD-5 Percussion Synthesizer Owner's Manual Contents

- Introduction** 1
- Features** 1
- Care and Maintenance** 1'
- XD-5 Panel Layout**..... 2'
- Names of Parts**..... 2
- Contents of Panel Nomenclature** 3
- Contents** 4
- How to use this Manual** 6
- Chapter 1.: Introduction**..... 7
 - 1-1. Instrument Setup** 8
 - 1-2. Let's Play!**..... 9
 - 1. Selecting a PLAY Mode (SINGLE or KIT) 9
- Chapter 2.: Applications** 11
 - 2-1. Saving and Loading Data** 12
(CARD FORMAT, DATA SAVE, DATA LOAD)
 - 2-2. Before Entering EDIT Mode** 14
 - 2-3. Editing a KIT Patch**..... 15
 - 1. KIT Patch Configuration 16
 - 2. Editing Parameters 17
 - EDIT Group..... 17
 - EDIT KEY 18
 - SINGLE..... 18
 - PITCH Group 19
 - LEVEL Group 20
 - 3. Editing Capabilities (COPY) 21
 - 4. Writing a KIT Patch 22
 - 2-4. Editing a SINGLE Patch** 23
 - 1. SINGLE Patch Configuration 24
 - 2. Editing Parameters 27
 - EDIT Group..... 28
 - COMMON Group 29
 - AUTO BEND Group..... 31
 - S-COMMON (Source COMMON) Group 32
 - DCO Group 33
 - DCA Group 34
 - DCA MOD(DCA Modulation) Group 35
 - DCF Group..... 37
 - DCF MOD (DCF Modulation) Group 38
 - 3. Editing Capabilities (COPY) 40
 - 4. Writing a SINGLE Patch 41

■ XD-5 Percussion Synthesizer Owner's Manual Contents

2-5. Editing a OUTPUT Patch	42
1. OUTPUT Patch Configuration	42
2. Editing Parameters	43
3. Writing a OUTPUT Patch	44
2-6. SYSTEM Programming	45
1. TRS (Transmit) Group	46
2. RCV (Receive) Group	46
3. SYS (SYSTEM) Group	48
Chapter 3: Advanced Applications	49
3-1. MIDI DATA DUMP	50
3-2. MIDI for the Advanced User	51
Appendices	53
A-1. Error Messages.....	53
A-2. Troubleshooting	54
A-3. Blank Chart.....	55
INDEX	56
MIDI Implementation Chart.....	58
Specifications	59

■ How to Use This Manual

This manual is composed of three chapters and appendices as shown below.

Chapter 1.: Introduction

- Instrument Setup
- Let's Play!

Chapter 2.: Applications

- Saving and Loading Data
- Before Entering EDIT Mode:
- Editing a KIT Patch
- Editing a SINGLE Patch
- Editing a OUTPUT Patch
- SYSTEM Programming

Chapter 3.: Advanced Applications

- MIDI Data Dump
- MIDI for the Advanced User

Appendices

- Error Messages
- Troubleshooting
- Blank Chart

Index

MIDI Implementation Chart

Specifications

Page 2' shows the panel layout of the XD-5. This page pulls out and can be seen while reading other pages.

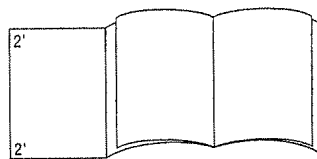

A section heading appears on the right side of each page, which makes it easy to locate a particular section of the manual. In addition, the primary subject covered on each page is shown in the upper right corner.

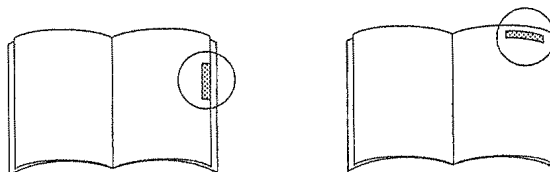

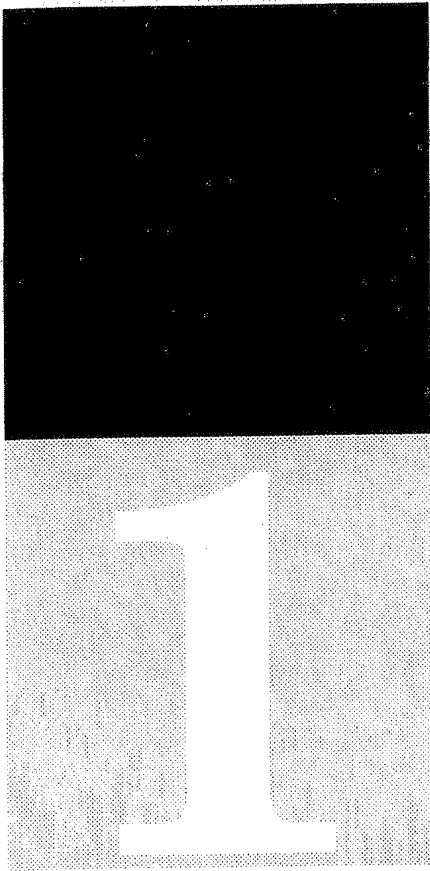

Chapter 1. Introduction

This chapter explains how to set up the XD-5 and the functions available when playing.

1-1. Instrument Setup

1. Making Connections

1-2. Let's Play!

1. Selecting a PLAY mode (SINGLE or KIT)

1-1. Instrument Setup

1. Making Connections:

How to set the unit up quickly and easily

- (1) Connect the power adapter and keyboard amp (or headphones) as shown in below.

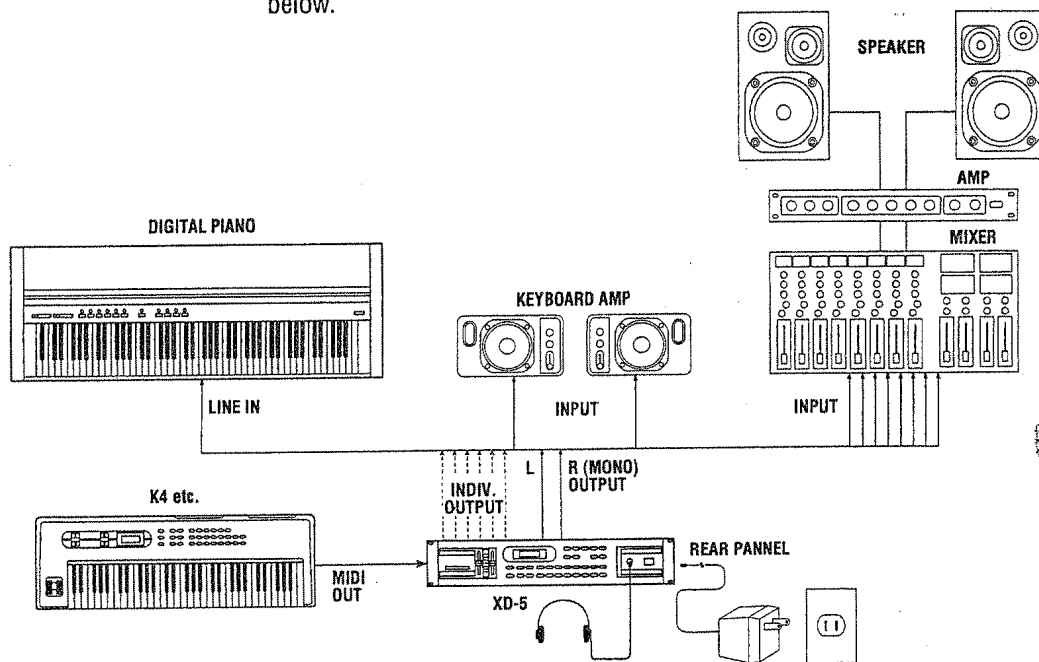

Note: The XD-5 has no internal power amp or speakers. In order to obtain sound output, you may either use headphones, or connect it to a keyboard amp or PA system. It is possible to use home radio cassette players or audio amps, but caution should be paid to when the power is turned on and to volume, etc., in order to avoid damage to these appliances.

* KAWAI XD-5 *
SYNTHESIZER

- (2) Turn the POWER switch at the right of the front panel on. This display lasts only a few seconds.

KIT
I -1 ACOUSTIC 1

- (3) The unit is now ready to play.
(4) Turn on the power of amps and other equipment connected to the XD-5 after turning the XD-5 on, to protect the other equipment.

1-2. Let's Play!

First, let's take a look at the tones currently stored into the memory of the XD-5.

1. Selecting a PLAY Mode (SINGLE or KIT)

The XD-5's individual tones are known as SINGLE patches. These patches may be assigned one to each of the 88 key numbers (from A-1 through C7) to form patches known as KIT patches. Since the XD-5 is designed for use as a percussion tone generator module, these KIT patches are likely to be used with the most frequency. For this reason, the KIT patch mode is automatically selected when the XD-5's power is turned on.

To summarize:

- SINGLE patchSingle tones are played.
- KIT patchTones are grouped to form a percussion set.





1) KIT Patch

The XD-5 is capable of remembering up to 16 different KIT patches. Each of these patches may be composed of total of 88 different percussion sounds as described above. To play all 88 of these sounds at any one time, an 88-key MIDI keyboard controller is required. Any of the following KAWAI products may be used for this purpose.

- MIDI Master Keyboard M8000
- Digital Piano MR370, MR270, MR3000, etc.

The 61-key MIDI keyboard or MIDI controller may be used to control the XD-5. In this case, there will be no keys immediately available to play the tones corresponding to key numbers A-1 through B-1 and D#6 through C7. To play these tones, use the MIDI controller's KEY TRANSPOSE function to shift the range of the note numbers transmitted to the XD-5 up or down as needed.

<Procedure>

- (1) Press  to switch to KIT Patch.
- (2) With every further press of the , the unit switches between the INT (inside the unit itself) and EXT (card) memories.
 - I: INT (internal) memory
 - E: EXT (card) memory
- (3) Select a number from  - .

KIT
I -1 ACOUSTIC 1



KIT
E -1 JAZZ SET 1

Selection

KIT
I -1 ACOUSTIC 1

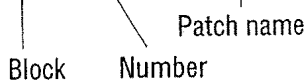

A KIT Patch has now been selected.







Refer to the attached "PATCH LIST (FACTORY PRESET)" to determine what tones are included in each KIT patch.



2) SINGLE Patch

64 different SINGLE Patches may be stored into the internal memory of the XD-5. These are stored into the four banks, A–D, each of which can store 16 patches (for a total of 64). Cards may also be used to store an additional 64 patches, 16 in each of the four banks from A–D.

<Procedure>

- (1) Press  to select SINGLE Patch.
- (2) With every further press of the , the unit switches between the INT (inside the unit itself) and EXT (card) memories.
 - I: INT (internal) memory
 - E: EXT (card) memory
- (3) Select a bank from  to .
- (4) Select a number from  – .
- (5) When switching between SINGLE Patches, if the patches are in the same bank, repeat step 4. When they are in the same block, repeat steps 3 and 4.

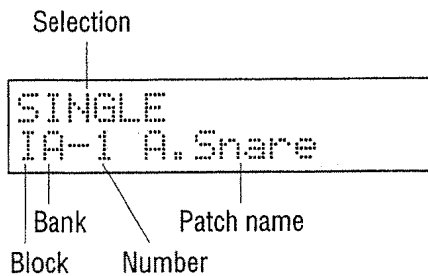
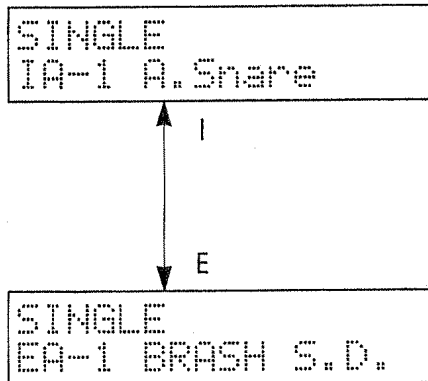

A SINGLE Patch has now been selected.

Refer to the attached "PATCH LIST (FACTORY PRESET)" to determine which tone is included in each SINGLE patch.

Note: You can hear the sound by using  without MIDI keyboard.

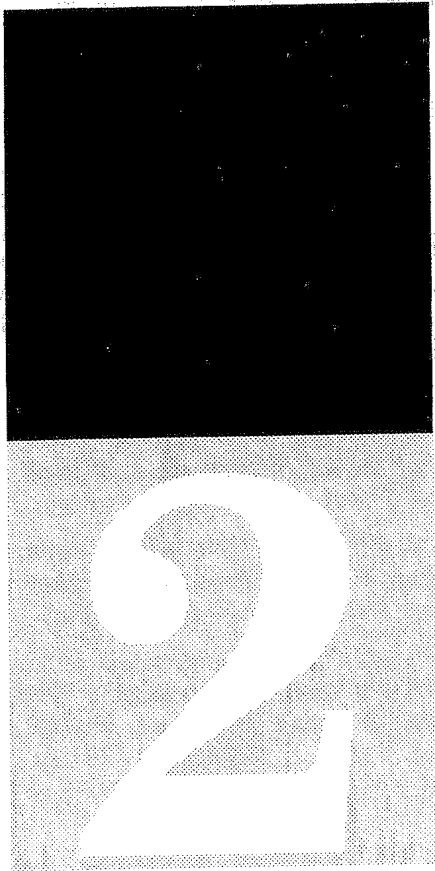

Chapter 2. Applications

This chapter explains the creation and editing of tone data, as well as how to combine the tones for a variety of setting and effects.

2-1. Saving and Loading Data

2-2. Before Entering EDIT Mode

2-3. Editing a KIT Patch

1. KIT Patch Configuration
2. Editing Parameters
3. Editing Capabilities (COPY)
4. Writing a KIT Patch

2-4. Editing a SINGLE Patch

1. SINGLE Patch Configuration
2. Editing Parameters
3. Editing Capabilities (COPY)
4. Writing a SINGLE Patch

2-5. Editing a OUTPUT Patch

1. OUTPUT Patch Configuration
2. Editing Parameters
3. Writing a OUTPUT Patch

2-6. SYSTEM Programming

1. TRS (Transmit) Group
2. RCV (Receive) Group
3. SYS (SYSTEM) Group

2-1. Saving and Loading Data

The memory of the XD-5 can hold 64 SINGLE Patches and 16 KIT Patches, for a total of 80 patches, plus 16 OUTPUT Patches. At the time your synthesizer left the factory, the "factory presets" (a selection of patches and settings designed to make good use of the XD-5's capabilities) were stored in its memory. You will find that editing these tones to create new ones suiting your taste an easy and pleasant task. Tones so edited can be stored in the memory, and will be described later; but the data originally stored there will be erased. In case you want to keep the factory presets, you should either store them in an optional card (DC-16) or copy them by MIDI DATA DUMP into a computer or a sequencer such as the Q-80.

Notes: Be sure to use only the designated memory card (DC-16).

When using a card, please read the accompanying instruction manual carefully.

Do not cut the synthesizer's power during a LOAD or SAVE operation, as it may destroy any data stored in the card and/or the synthesizer's memory.

Should you wish to SAVE or LOAD individual patches, please refer to the descriptions of the WRITE operations in each Section. (For KIT Patches, see P. 22; for SINGLE Patches, see P. 41; for OUTPUT Patches, see P. 44.)

CARD FORMAT

New cards and cards which have been used in other machines must be formatted before they can be used with the XD-5.

Note: When the FORMAT procedure is performed, all data already stored in the card will be erased. PROTECT will not work when formatting, so be sure to check the contents of a card before you format it.

CARD FORMAT
EXEC? = Y/N

CARD FORMAT
SURE? = Y/N

+YES

COMPLETED!

-NO

CANCELED!

<Procedure>

- (1) Insert the card into the card slot (in the front panel of the XD-5) so that the ▼ mark and the ▽ mark are aligned.
- (2) Press WRITE repeatedly until CARD FORMAT appears on the display.
- (3) Press +YES to FORMAT, or -NO to quit.
- (4) If you press +YES, the message SURE? will appear on the display to ask for confirmation.
- (5) Press +YES again to continue, or -NO to quit.
- (6) Continue with the SAVE operation.

DATA SAVE

This procedure copies all patch data from the synthesizer to the card.

Note: When the SAVE procedure is performed all data already stored in the card will be erased.

SAVE TO CARD
EXEC? = Y/N

+YES

COMPLETED!

-NO

CANCELED!

<Procedure>

- (1) Press WRITE repeatedly until SAVE appears on the display.
- (2) Press +YES to SAVE, or -NO to quit.
- (3) If you press +YES, the message SURE? will appear on the display to ask for confirmation.
- (4) Press +YES again to continue, or -NO to quit.
- (5) Press WRITE repeatedly until CARD PROTECT appears on the display.
- (6) To protect the card data, set the memory PROTECT switch to ON.
(See DATA LOAD below)

DATA LOAD

This procedure copies all patch data from the card into the synthesizer.

Note: When the LOAD procedure is performed all data already stored in the synthesizer will be erased.

INTERNAL
PROTECT =ON

LOAD FROM CARD
EXEC? = Y/N

LOAD FROM CARD
SURE? = Y/N

+YES

COMPLETED!

-NO

CANCELED!

<Procedure>

- (1) Insert the card into the card slot (in the front panel of the XD-5) so that the ▼ mark and the ▽ mark are aligned.
- (2) Press WRITE repeatedly until INTERNAL PROTECT appears on the display.
- (3) Press -NO to turn the PROTECT switch to OFF.
- (4) Press WRITE repeatedly until LOAD appears on the display.
- (5) Press +YES to LOAD, or -NO to quit.
- (6) If you press +YES, the message SURE? will appear on the display to ask for confirmation.
- (7) Press +YES again to continue, or -NO to quit.
- (8) To protect internal patch data, return the Internal PROTECT switch to ON.

2-2. Before Entering EDIT Mode

The Basics of Editing

Editing is the creation or alteration of synthesizer tones and settings. This operation can be performed in the EDIT mode.

Note: You will need to use the WRITE operation to store edited data for future use.

```
SNGL WRITE
TO           =IA-1
```

```
SNGL WRITE SIA-1
EXEC?= Y/N
```

Note: Data that is not stored using the WRITE operation will not be changed in the memory. Therefore, feel free to try editing the preset data and see how each setting change affects the actual sound produced.

How to Enter EDIT Mode

You may edit SINGLE Patches in SINGLE EDIT mode, and KIT Patches in KIT EDIT mode. Entering EDIT mode is the same in either case.

```
SINGLE
IA-1 A.Share
```

```
SIA-1 A.Share
VOLUME      =100
```







<Procedure>

- (1) Call up the patch to be edited on the display.
- (2) Press  to enter EDIT mode.

Calling up Parameters and Assigning Values on the XD-5

Parameters are divided into groups according to function, and then assigned to various switches.

<Procedure>

- (1) The parameter groups are assigned to switches A, B, C, D, and 1 through 16 on the panel. Press the switch for the proper parameter group repeatedly until the desired parameter appears on the display.
- (2) If you accidentally pass the parameter you want, press  to return to it.
- (3) The VALUE Slider may be used to change the value greatly; to change it slightly, press  or .
- (4) To compare the edited sound with the original, press . The value before editing will appear on the display, and you can hear the original sound.
- (5) Press the  again to continue editing.
- (6) To stop editing, press  or .

2-3. Editing a KIT Patch

The technical parameters for a KIT Patch are shown below.

KIT EDIT

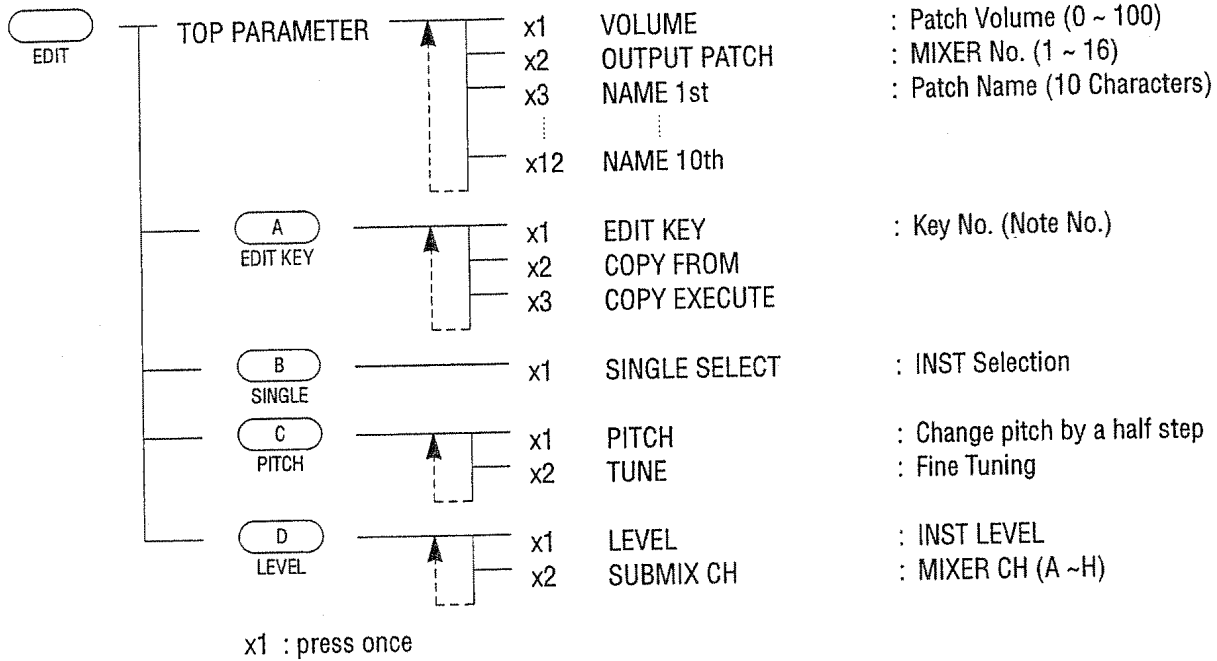

1. KIT Patch Configuration

Recent rhythm machines are configured in such a way that their internal tones may be assigned to pads, or switches which cause the tone to sound when pressed. The XD-5's tones may each be assigned to a key number in a similar fashion. The key numbers to which tones may be thus assigned include those corresponding to the 88 keys from A-1 through C7, that is the 88 keys which make up a standard piano keyboard. Each of the XD-5's KIT patches consists of a group of 88 tones, each tone being assigned to a different key number.

Whenever a tone is assigned to key, a decision about each of the following six items must be made:

- | | |
|-------------------|--|
| (1) EDIT KEY | Determines which key number a tone is to be assigned to. |
| (2) SINGLE SELECT | Determines which tone is assigned to the key number in question. |
| (3) PITCH | Determines the pitch at which the tone is assigned to the key. |
| (4) TUNE | Determines the fine tuning of the tone. |
| (5) LEVEL | Determines the tone's volume. |
| (6) SUBMIX CH | Determines the output jack from which the tone is output. |

When the above decisions are made and programmed for each of the 88 key numbers, the result is a single KIT patch. The XD-5 is capable of remembering a total of up to 16 such KIT patches. The user may select from among these patches, one at a time, to suit the style of each song that is played. Note that it is not inconceivable that a single KIT patch should meet the user's needs most of the time, since a single KIT patch can contain 88 different tones. Nonetheless, we hope that each user will be able to achieve his or her own special, individual percussion sound by switching freely between the 16 KIT patches.

■ Display During Editing

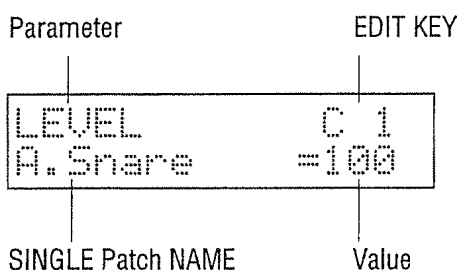

Note: You can hear the sound by using  without MIDI keyboard.

2. Editing Parameters

■ EDIT Group

```

KI -1 ACOUSTIC 1
VOLUME      =100
  
```

```

KI -1 ACOUSTIC 1
OUTPUT PACH= 16
  
```

```

KI -1 ACOUSTIC 1
NAME        10th= 1
  
```

Sets the parameters which affect the performance of an entire KIT patch.

● VOLUME

(Value: 0 ~ 100)

This controls the volume of the entire KIT Patch. Adjust the differences in volume between patches so that there is no unnatural change in loudness when patches are switched.

● OUTPUT Patch

(Value: 1 ~ 16)

Select the OUTPUT Patch to be used from the 16 OUTPUT Patches previously set. (See P. 40 ~ 42)

● NAME (1st - 10th)

Edited patches are given names consisting of ten characters.

Notes: Move the cursor with the and then select a number or letter with the VALUE Slider, and .

The following list gives the characters which may be used for a patch name.

Valid name characters

■, !, ", #, \$, %, &, ', (,), *, +, -, ., /

0, 1, 2, 3, 4, 5, 6, 7, 8, 9

!, !, <, =, >, ?, @

A, B, C, D, E, F, G, H, I, J, K, L, M, N, O, P, Q, R, S, T, U, V, W,

X, Y, Z

[, \,], ^, _ , `

a, b, c, d, e, f, g, h, i, j, k, l, m, n, o, p, q, r, s, t, u, v, w,

x, y, z

(, |,), +, =

The following parameters are set individually for each key number:

■ EDIT KEY

EDIT KEY	C 1
A. Snare	=C 1

● EDIT KEY

(Value: A-1 ~ C7)

This designates the key number for which a setting is to be made.

Use the value slider or and to select a key number.

+YES

-NO

Note: This selection may also be made using the note number data from an external MIDI controller. If an 88-key MIDI keyboard is available, then the key number for which the parameter setting is to be made may be selected simply by pressing the appropriate key. It is possible to use this direct key number designation method with some of the other KIT edit mode edit displays as well; in these cases the number of the key depressed will appear on the right-hand side of the top line of the display. This method cannot however be used with the overall patch volume, output, and name setting displays. This is because these three displays are used to set parameters common to the entire patch, and not for settings which are made one key at a time.

● COPY

(See page 21)

■ SINGLE

SINGLE	C 1
A. Snare	=IA-1

● SINGLE

(Value: INT -- IA-1 ~ ID-16, EXT -- EA-1 ~ ED-16)

This selects the SINGLE patch which will be played when the key designated using the KEY NO. parameter is depressed.

Use the VALUE Slider or and to select the SINGLE Patch.

+YES

-NO

Note: The unit's internal KIT Patches cannot use SINGLE Patches on the cards. Similarly, the card's KIT Patch cannot use the machine's internal SINGLE Patches.

Since SINGLE tones used in a KIT Patches are controlled by patch numbers, changing the contents of a SINGLE Patch will also change the sound within the KIT Patch.

■ PITCH Group

PITCH	C 1
A. Snare	=C 3

● PITCH

(Value: C-2 ~ G7)

This designates the pitch setting for the SINGLE patch selected using the SINGLE SELECT parameter. In the display at left, the sound corresponding to key C3 of the SINGLE patch selected will be played by key C1 of the KIT patch. This parameter thus allows the setting of one SINGLE patch at various pitches for several notes, thus allowing a variety of sounds -- or the user can even devote an entire octave to a single tone, allowing melodic percussion play for instruments such as the marimba.

Use the value slider or +YES and -NO to select a PITCH.

Note: When the KEY TRACK parameter for the SINGLE patch selected is set to "OFF" (so that the same pitch is produced when any key is hit), settings made using the PITCH parameter will be ignored.

● TUNE

(Value: -50 ~ +50)

This allows fine adjustment of the pitch set using the PITCH parameter, within a range of one half-tone upward or downward.

Use the value slider or +YES and -NO to select the TUNE.

This setting is handy in adjusting the pitch of the various instrument sounds which make up a KIT patch to match each other. The need for such adjustment becomes apparent only when a drum set is assembled and actually played together.

TUNE	C 1
A. Snare	=+50

■ LEVEL Group

LEVEL	C 1
A. Snare	=100

● LEVEL

(Value: 0 ~ 100)

This adjusts the volume of the SINGLE patch tone selected for the key number in question.

Use the value slider or +YES and -NO to select the VOLUME.

● SUBMIX CH

(Value: A ~ H)

This designates which of the eight preset SUBMIX channels (designated by a letter A through H) the SINGLE patch selected for the key number in question will be output.

Use the value slider or +YES and -NO to select an SUBMIX channel.

SUBMIX CH	C 1
A. Snare	=A/16

Note: The SUBMIX channel designated is displayed for reference in the lower right-hand corner of the display. If a number from -7 to +7 is displayed, then the audio signal will be output through the LEFT and RIGHT stereo output jacks. (Negative values mean the sound will be panned toward the RIGHT side, whereas positive values mean the sound will be panned toward the LEFT.) Values from 11 through 16 indicate that the sound will be output from a corresponding individual output jack. However, the SUBMIX channel setting may not be changed using this parameter. To make a change in the setting, press the OUTPUT key and edit the OUTPUT patch appropriately.

3. Editing Capabilities (COPY)

It is possible to copy the SINGLE patch data assigned to one key as is to any other key within a KIT patch. This is useful when assigning the same SINGLE patch data to several keys, changing only the patch for each key.

<Procedure>

```
COPY          C 1
FROM          KEY=G 1
```

- (1) Press the EDIT KEY several times until the COPY display is displayed.

- (2) Select the KEY No. from which you want to copy by using the Value Slider or and .

```
COPY          C 1
FROM          EXEC?= Y/N
```

- (3) Press the EDIT KEY again. The message "EXEC?" will then appear. Press to copy or to cancel.

```
COPY          C 1
FROM          SURE?= Y/N
```

- (4) If you pressed in step (3), the message "SURE?" will appear to ask you for confirmation. Press to copy or to cancel.

4. Writing a KIT Patch

This is done to store the edited patch in memory.

If you write the data, any data previously stored will be written over. Save patches you don't want to lose on the optionally available card (DC-16), or store it in a computer or sequencer such as the Q-80 using the MIDI DATA DUMP. (See P. 50)

<Procedure>

Notes: First of all, turn off the PROTECT for the unit (or card) so that writing can be done.

```
INTERNAL
PROTECT      =OFF
```

```
CARD
PROTECT      =OFF
```

```
KIT WRITE
TO           =I  -1
```

```
KIT WRITE KI -1
EXEC? = Y/N
```

- (1) While in the KIT EDIT mode, press the several times to display the PROTECT screen.
- (2) Press the to turn off the PROTECT.
- (3) Press the several times to display the WRITE screen.
- (4) Select the number of the patch you want to write with the VALUE Slider, and press .
- (5) The message "EXEC?" will then appear. Press to execute writing or to cancel.
- (6) If you pressed in step (5), the message "SURE?" will appear to ask you for confirmation. Press to execute writing or to cancel.

If necessary, set the PROTECT to ON.

Note: A new card must be formatted before it can be written to. (See P. 12)

2-4. Editing a SINGLE Patch

The technical parameters for a SINGLE Patch are shown below.

SINGLE EDIT

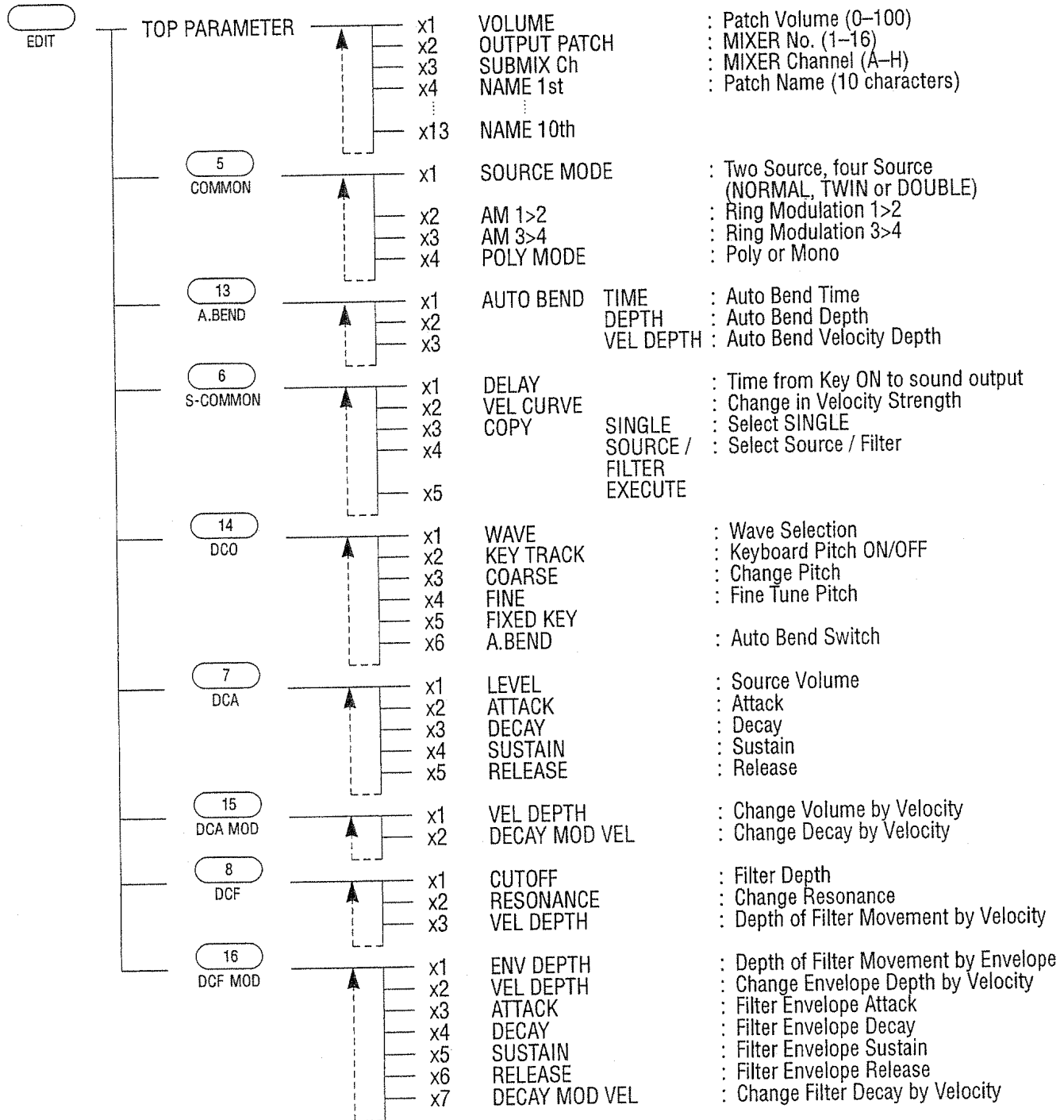

x1 : press once

SINGLE EDIT

1. SINGLE Patch Configuration

This section describes the process from the reception of a KEY ON signal to the actual production of a sound, and explains how each part of the XD-5 operates.

■ The Sound Production Process

The XD-5 configuration consists of three blocks: DCO, DCA, and DCF.

● DCO

The DCO receives information from the keyboard concerning which key is pressed, and outputs the preselected basic tone (either DC or PCM waveform) at the pitch of the key that was pressed.

● DCA

The DCA adjusts the volume of the signal sent from the DCO. It does not merely set the output volume of the signal; it determines the change in the signal's volume over a period in time as well.

● DCF

The DCF adjusts the sound quality of the tone sent from the DCA. The DCF basically operates like a tone control; however, they are essentially different in that the DCF adjustment can be set to vary over time.

● INDIVIDUAL OUTPUT

In addition to the stereo left and right output jacks, the XD-5 has six Individual Output jacks. In KIT Patch, for example, by outputting the kick through Individual Output jack #1, the snare through jack #2, the cymbals through jack #3, and the other drums through the stereo jacks it is possible to process each sound differently through external effects devices.

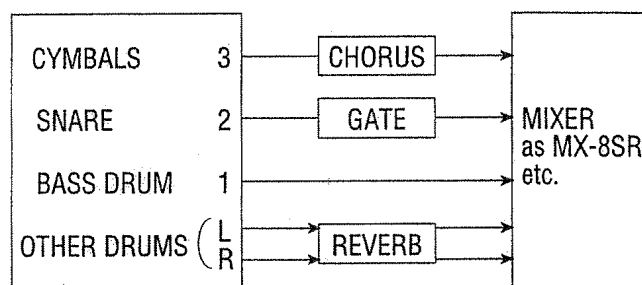

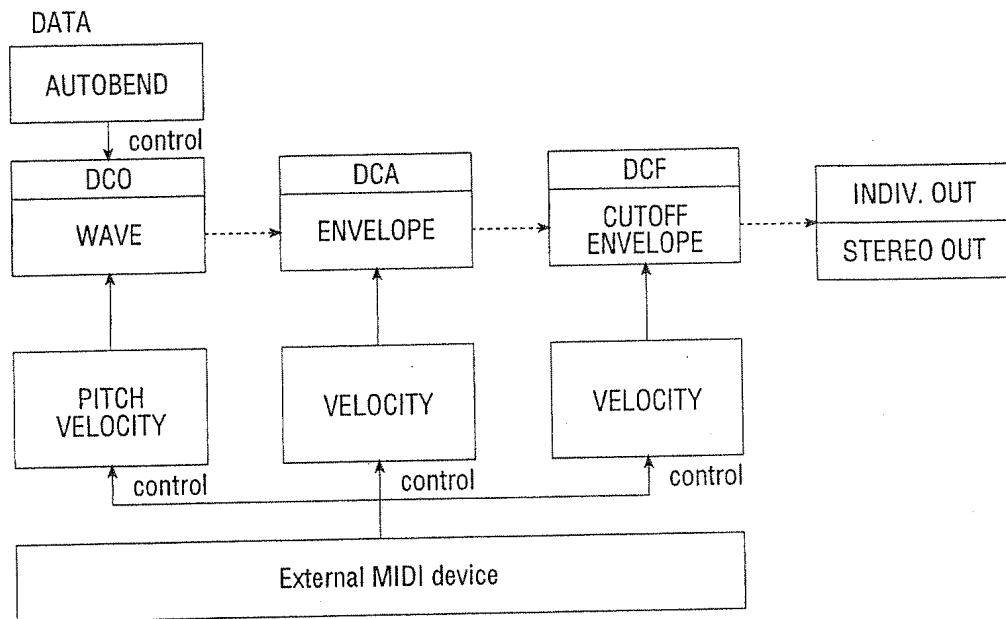

SINGLE EDIT

■ The XD-5 Tone Generator

The XD-5 produces sounds by a system known as DMS Tone Generation. Natural sounds exhibit complex variations in harmonic composition which are very difficult, if not impossible, to reproduce artificially using a single waveform, as would be the case with a conventional synthesizer. DMS Tone Generation makes sound creation easy by temporarily separating the sound into its component elements. It is comparatively easy to create even complex harmonic variations by combining these elements. The XD-5 is capable of separating a tone into up to four such elements.

■ The XD-5's Internal Waveforms

By combining the characteristics of PCM and DC waveforms, the XD-5 allows free creation of a wide variety of tones.

● PCM Waveforms

Conventional synthesizers were able to produce only waveforms such as triangle or sawtooth waves having comparatively simple harmonic configurations. They could not produce metallic sounds and other tones with complicated harmonic components. The XD-5 has solved this problem by making use of 16 bit 44.1 kHz sampled PCM waveforms.

Note: *PCM, or Pulse Code Modulation, is a method of reproducing sounds such as those of acoustic instruments by converting them into a digital signal and recording them. The XD-5's internal PCM waveforms have a reproduction quality equal to that of a CD.*

● DC (Digital Cyclic) Waveforms

DC waveforms consist of Cyclical PCM sounds which have been analyzed and recombined so that they are easy to process. It is useful to combine DC waveforms with PCM waveforms or with other DC waveforms for best results.

■ AM (Ring Modulation)

AM (Ring Modulation) is a system which combines two signals to create a single, more complex signal. One waveform is used to modulate or cause a change in the other, so unlike the DCF, which reduces harmonics, this system can produce new harmonics which were not included in either original waveform, allowing the creation of metallic, distorted or otherwise forceful sounds.

Note: *Keep in mind that it is important to give careful consideration to the extent of level modulation when using AM. (See P. 29)*

2. Editing Parameters

■ Choosing a Source to Edit

Each Source must be set individually for SINGLE Patches.

<Procedure>

- (1) Select the Source to be edited using the Source Select switches 1, 2, 3, or 4.

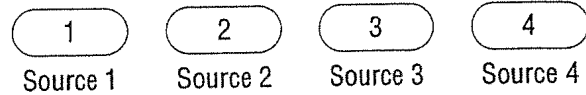

- (2) To listen to a Source's sound individually, use the Source Mute switches 9, 10, 11, and 12 to mute the other Sources temporarily.

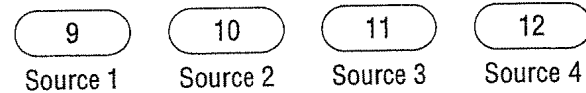

- (3) When editing Filter parameters, select the desired Filter using the Source Select switches 1, 2 (for Filter 1) and 3, 4 (for Filter 2) as below:

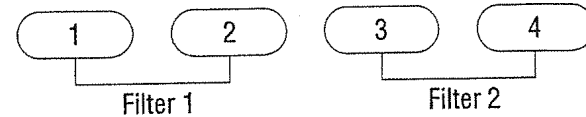

SINGLE EDIT

■ Display During Editing

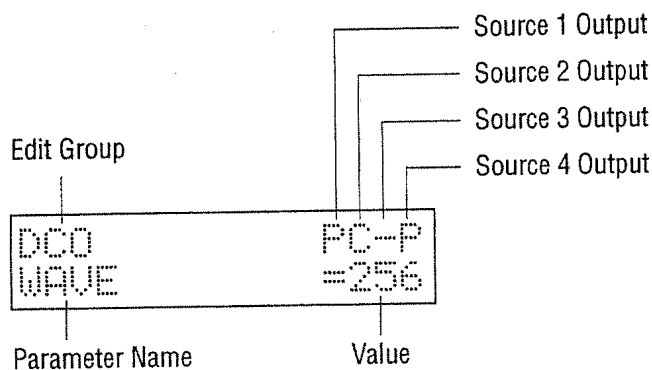

P: PCM WAVE
C: DC WAVE
-: Mute/Level 0

■ EDIT Group

```
SIA-1   A.Share
VOLUME   =100
```

```
SIA-1   A.Share
OUTPUT PACH= 16
```

```
SIA-1   A.Share
SUBMIX CH =H/-?
```

```
SIA-1   A.Share
NAME 1st   = A
```

● VOLUME

(Value: 0 ~ 100)

This controls the volume of all SINGLE Patches. The differences in volume between patches are adjusted so as to avoid any unnaturalness when switching between patches.

● OUTPUT Patch

(Value: 1 ~ 16)

This allows selection from among the 16 OUTPUT Settings made previously. (See P.42)

● SUBMIX CH

(Value: A ~ H)

The XD-5 has stereo L, R and six Individual Output jacks. A single OUTPUT Patch contains eight different SUBMIX CH settings that determine the panning through the stereo outputs or assignment to the individual output jacks. This allows you to select which SUBMIX CH to use. (See P.42)

● NAME (1st - 10th)

Edited patches are given names consisting of ten characters.

Notes: Move the cursor with the and then select a number or letter with the VALUE Slider, and .

The following list gives the characters which may be used for a patch name.

Valid name characters

■, !, ", #, \$, %, &, ', (,), *, +, ,, -, ., /

0, 1, 2, 3, 4, 5, 6, 7, 8, 9

:, ;, <, =, >, ?, @

A, B, C, D, E, F, G, H, I, J, K, L, M, N, O, P, Q, R, S, T, U, V, W, X, Y, Z

[, \,], ^, _

a, b, c, d, e, f, g, h, i, j, k, l, m, n, o, p, q, r, s, t, u, v, w,

x, y, z

<, |, >, ~, €

COMMON Group

These are set to act on all Sources of a SINGLE Patch.

```
COMMON      EDCOP
SOURCE MODE=DBL
```

● Source mode

(Value: NORM, TWIN, DBL)

Combinations of DCO and DCA are called "Sources." With the XD-5, four Sources may be combined to create a tone.

This sets the Source combination and how the Filter will be used with the Source.

[Normal]

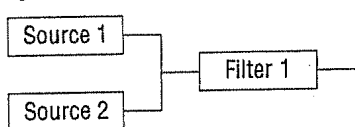

[Twin]

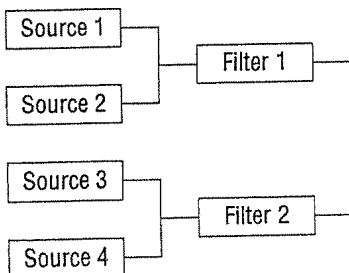

[Double]

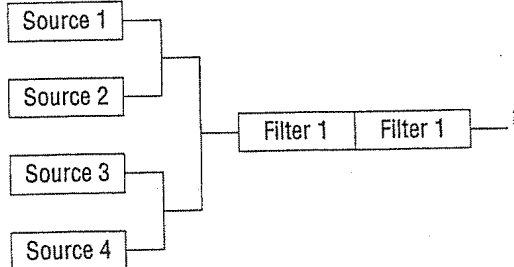

SINGLE EDIT

Note: Choosing "TWIN" or "DBL" makes the XD-5 an 8-voice polyphonic instrument – that is, limited to sounding a maximum of 8 notes at a time.

● AM (Ring Modulation)

(Value: ON or OFF)

This sets whether the Ring Modulation wave type is to be used with Source 1 (3). When this value is ON, wave 1 (3) is used to distort wave 2 (4).

```
COMMON      EDCOP
AM1 >2      =ON
```

Note: When AM is in use, Source Mute is enabled. A setting may be made as to whether to output or mute the modulating sound. (See P. 27)

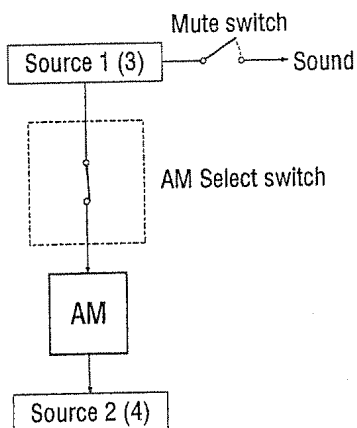

COMMON	ECCP
POLY MODE	=PLY1

- **POLY mode**

(Value: PLY1, PLY2, SOLO)

Sets the way the SINGLE Patch is to sound.

- **PLY1 (Poly 1)**

This mode cuts off the previous note each time the same note is struck.

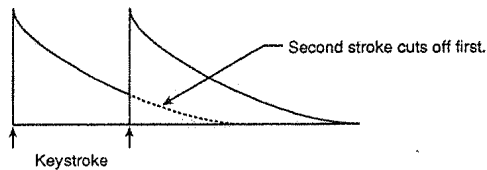

- **PLY2 (Poly 2)**

This mode allows the previous note to sound each time the key is struck. When the number of tones which may be created at one time is exceeded, the tone of the next key pressed will take priority.

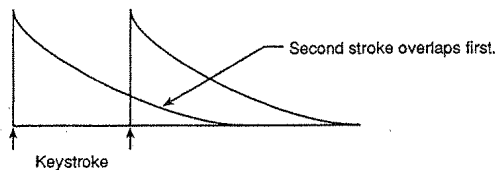

- **SOLO**

This is used to produce only monophonic sound without harmony.

Note: When one key is held down and another key pressed, the tone produced by the first key will disappear.

AUTO BEND Group

Pitch Bend can be set to go into effect automatically upon the strike of a key. When the set value is made small, the pitch changes of sounds characteristic to ethnic and lead instruments can be reproduced. When the value is made large, effects such as tabla and electric tom can be created.

```
AUTO BEND  BCCP
TIME        =100
```

- **TIME**
(Value: 0~100)
Sets the Auto Bend time duration.

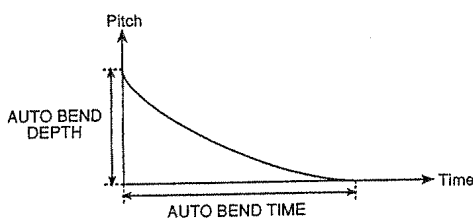

Value	Effect
0	No effect
}	}
100	Maximum period

SINGLE EDIT

```
AUTO BEND  BCCP
DEPTH      =-50
```

- **DEPTH**
(Value: -50~+50)
Sets the pitch variation amplitude for Auto Bend.

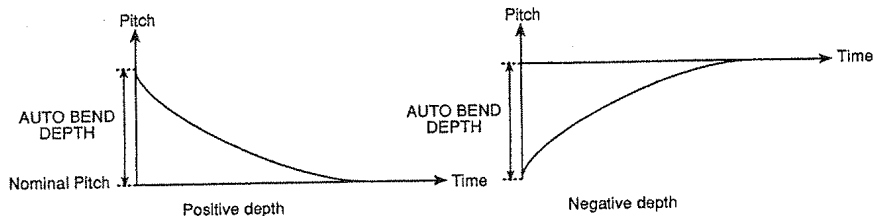

Value	Effect
+50	Pitch drops to nominal value
}	}
0	No effect
}	}
-50	Pitch rises to nominal value

```
AUTO BEND  BCCP
VEL DEPTH  =-50
```

- **VEL DEPTH**
(Value: -50~+50)
Auto Bend pitch depth of change can be varied depending on the amount of velocity while playing.

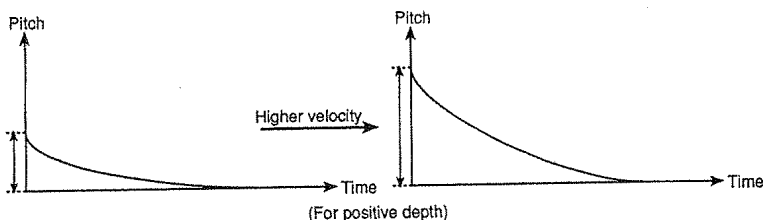

Value	Effect
+50	Depth increases with velocity
}	}
0	No effect
}	}
-50	Depth decreases with velocity

■ SOURCE COMMON (S-COMMON) Group

This sets the following parameters for each Source:

● DELAY

(Value: 0~100)

This sets the time for each Source from the point the key is struck to the point when attack begins.

```
S. COMMON      PCCP
DELAY          =100
```

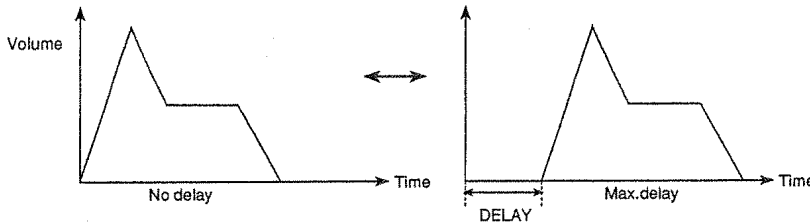

Value	Effect
0	0
5	5
100	Max. delay

● VEL (Velocity) CURVE

(Value: 1~8)

You can select the way in which volume and tone are changed by how hard the key is struck, choosing from the following eight curves.

```
S. COMMON      PCCP
VEL CURVE     = 8
```

VEL CURVE DIAGRAM	
1	<p>This is an easy-to-use, orthodox curve. Volume rises linearly with key velocity.</p>
2	<p>With this curve, the volume rises rapidly with a light touch.</p>
3	<p>This curve rises from low to high volume exponentially, making it suitable for deeply emotive tones.</p>
4	<p>This curve is somewhat deeper than curve 3.</p>
5	<p>This can be used as a SINGLE Velocity switch when combined with curve 6. No sound is played if the key is struck with force.</p>
6	<p>This can be used as a SINGLE Velocity switch when combined with curve 5. Sound is played only if the key is struck with force.</p>
7	<p>With this curve, volume rises sharply at first, maintains a medium level, the sharply increases at maximum force.</p>
8	<p>This curve stays low throughout much of the velocity range. It makes possible quiet, subtly expressive tones.</p>

● COPY

(See page.40)

DCO Group

The DCO sets the values for waveform and pitch.

DCO WAVE	ECCP =256
-------------	--------------

- **WAVE**

(Value: 1 to 41 (C), 42 to 256 (P))

This selects the desired waveform for each Source from the 256 waveforms available.

See the *WAVE LIST* packed with the unit for available waveforms.

DCO KEY TRACK	ECCP =ON
------------------	-------------

- **KEY TRACK**

(Value: ON or OFF)

This selects whether pitch is to change depending on the key struck. The keys scale normally when ON, but will be fixed at the pitch specified by **FIXED KEY** when OFF.

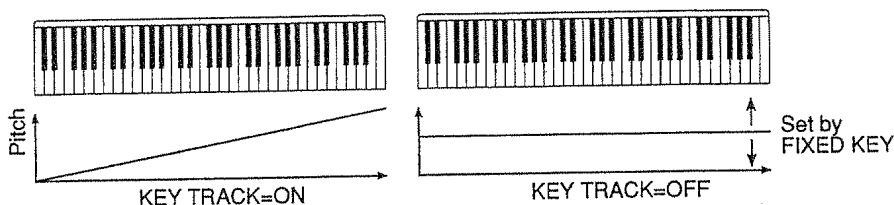

DCO COARSE	ECCP =-24
---------------	--------------

- **COARSE**

(Value: -24~+24)

This sets the pitch of each Source in half steps. You can make settings within a range of two octaves up or down.

DCO FINE	ECCP =-50
-------------	--------------

- **FINE**

(Value: -50~+50)

Fine tune the pitch of the Sources.

DCO FIXED KEY	ECCP =C -1
------------------	---------------

- **FIXED KEY**

(Value: C-2~G7)

Fix the pitch of each Source to a particular pitch.

Note: This setting can only be made when **KEY TRACK** is OFF.

DCO AUTO BEND	ECCP =ON
------------------	-------------

- **AUTO BEND**

(Value: ON or OFF)

This selects whether Auto Bend will affect the pitch. (See P. 31)

■ DCA Group

The DCA sets the values for volume of a sound over time.

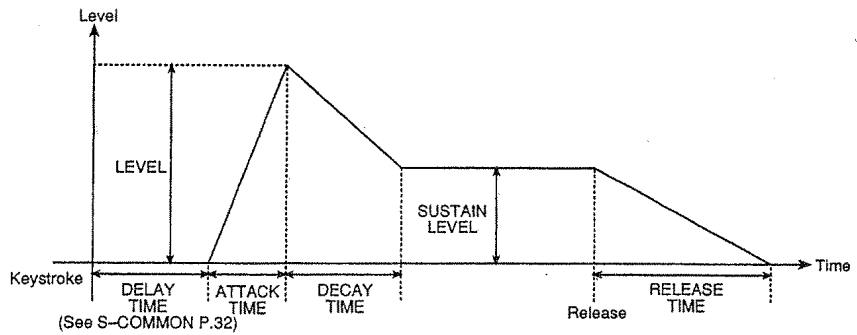

● **LEVEL**

(Value: 0~100)

This adjusts the initial level for each Source.

```
DCA          EDCP
LEVEL        =100
```

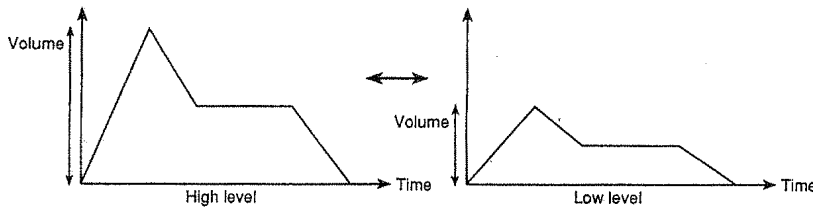

Value	Effect
0	No output (mute)
5	5
100	Maximum level

● **ATTACK**

(Value: 0~100)

This sets the time from the start of the sound until peak volume is reached (for each Source).

```
DCA          EDCP
ATTACK       =100
```

● **DECAY**

(Value: 0~100)

This sets the time from peak volume to the sustain level (for each Source).

```
DCA          EDCP
DECAY        =100
```

● **SUSTAIN**

(Value: 0~100)

This sets the stable level which will be maintained as long as the key is held down (for each Source).

```
DCA          EDCP
SUSTAIN      =100
```

● **RELEASE**

(Value: 0~100)

This sets the time from the point when the key is released until the sound disappears (for each Source).

```
DCA          EDCP
RELEASE      =100
```

■ DCA MODULATION (DCA MOD) Group

The DCA MOD is used to modulate the level with the keys.

● VEL (Velocity) DEPTH

(Value: -50~+50)

This adjusts the amount of change in volume by how hard the key is struck (for each Source). Setting a negative value makes the sound quieter the harder you hit the key.

```
DCA MOD      BCCP
VEL DEPTH    ==-50
```

Note: This sets the change according to the S-COMMON Velocity Curve. (See P. 32)

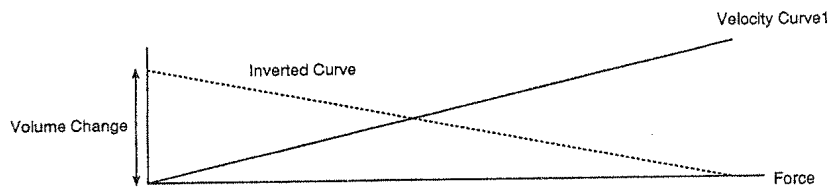

Value	Effect
+50	Maximum effect with normal velocity curve
}	}
0	No effect
}	}
-50	Maximum effect with inverted velocity curve

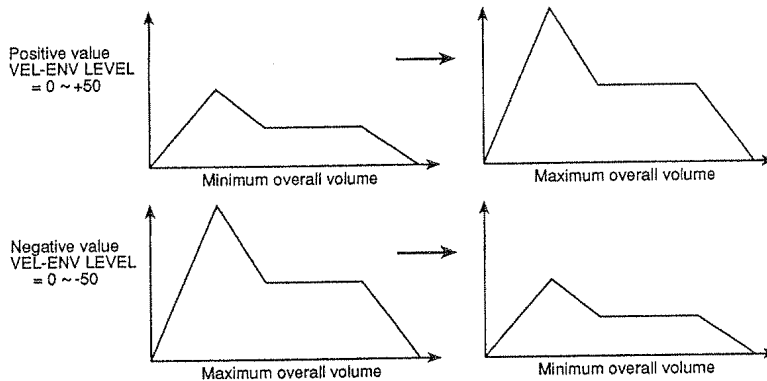

SINGLE EDIT

```

DECAY MOD      BCCP
VEL            =-50
    
```

● **DECAY MODULATION VELOCITY (VEL)**

(Value: -50~+50)

This controls the decay time according to how hard the key is struck (for each Source). Setting a positive value changes the decay according to the Velocity Curve set with S-COMMON, while a negative value will change the decay according to the inverse of the Velocity Curve. (See P. 32)

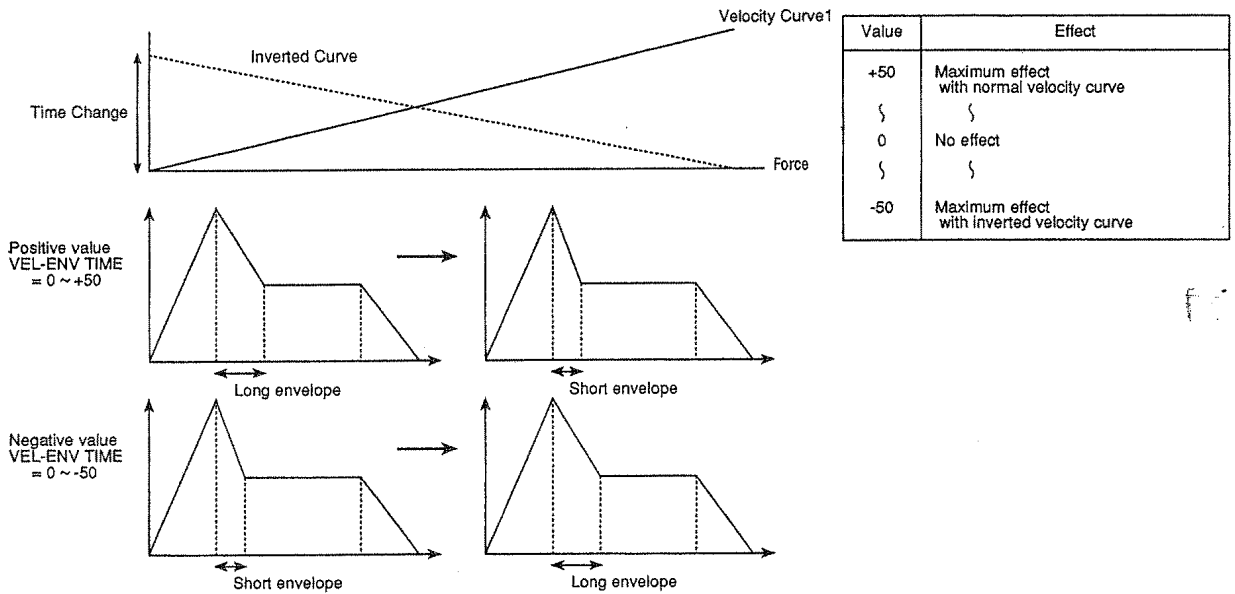

DCF Group

The DCF sets the values for the tone filter.

Note: When in the TWIN Source mode, select the Filter by pressing a Source Select (1 to 4). You can select the Filters for Sources 1 and 2 with switches 1 and 2, and the Filters for Sources 3 and 4 with switches 3 and 4.

```
DCF          EDCP
CUTOFF      =100
```

● CUTOFF

(Value: 0~100)

The basic function is the same as an analog Low Pass Filter. A tone generator waveform containing many harmonics is adjusted by a Low Pass Filter, which cuts off all harmonics above a specified Cutoff value. The higher this value is, the more brilliant the sound.

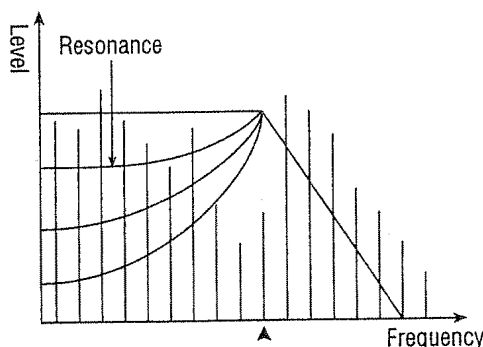

CUTOFF POINT
(Harmonics with frequencies higher than this value are Cutoff.)

Note: No sound will be heard if you set this value too low.

● RESONANCE

(Value: 0~7)

This sets the level near the Cutoff Frequency. The larger you set this value, the more emphasis is given to the particular frequency, resulting in a sharp, ringing tone.

```
DCF          EDCP
RESONANCE    = 7
```

Note: Especially sharp timbres can be created in the DOUBLE Source mode. The tone will be distorted if you set this value too high.

● VELOCITY DEPTH (VEL DEPTH)

(Value: -50~+50)

This adjusts the amount Velocity Modulation of the Filter Cutoff Frequency. Setting a positive value makes the sound brighter the harder the key is struck. Setting a negative value makes the sound less brilliant the harder the key is struck. (See P. 32)

```
DCF          EDCP
VEL DEPTH    =-50
```

3. Editing Capabilities (copy)

The COPY function is a handy shortcut if there is a Source or Filter similar to the one you want to use in a different patch or even the current patch.

First of all, select the patch containing the Source or Filter you want to use.

<Procedure>

```
COPY          EDCP
FROM SINGLE=IA-16
```

(1) Press the S-COMMON several times until the PATCH SELECT display is displayed.

(2) Select the patch with the VALUE Slider or and .

Note: The copy function copies from a patch as stored in memory. If you want to copy a Source or Filter from a patch being edited, write it to memory before performing the COPY.

(3) Next, select the Source or Filter that you want to copy.

```
COPY          EDCP
FROM SOURCE=51
```

Press the S-COMMON several times until SOURCE SELECT is displayed.

(4) Select the Source or Filter with the VALUE Slider or and . Values are as follows:

S1: Copy the entire contents of Source 1.

⋮

S4: Copy the entire contents of Source 4.

F1: Copy the entire contents of Filter 1.

F2: Copy the entire contents of Filter 2.

```
COPY          EDCP
FROM EXEC?= Y/N
```

(5) Press the S-COMMON. The message "EXEC?" will then appear. Press to copy or to cancel.

```
COPY          EDCP
FROM SURE?= Y/N
```

(6) If you pressed in step (5), the message "SURE?" will appear to ask you for confirmation. Press to copy or to cancel.

4. Writing a SINGLE Patch

Save the edited patch in memory.

Note: If you write the data, any data previously stored will be written over. Save patches you don't lose on the optionally available card (DC-16), or store them in a computer or sequencer such as the Q-80 using the MIDI DATA DUMP. (See P. 50)

Make sure that the PROTECT is OFF, and perform the following procedure.

<Procedure>

- (1) Press the several times to display the WRITE screen.
- (2) Use the VALUE Slider or the and to select the number of the patch to be written, and then press the .
- (3) The message "EXEC?" will then appear. Press to execute writing or to cancel.
- (4) If you pressed in step (3), the message "SURE?" will appear to ask you for confirmation. Press to execute writing or to cancel.
- (5) Press the several times to display the PROTECT screen, and then turn the PROTECT switch back on.

```
SNGL WRITE
TO          =IA-1
```

```
SNGL WRITE SIA-1
TO          EXEC?= Y/N
```

Note: A new card must be formatted before it can be written to (P.12).

SINGLE EDIT

2-5. Editing a OUTPUT Patch

The technical parameters for a OUTPUT Patch are shown below.

OUTPUT EDIT

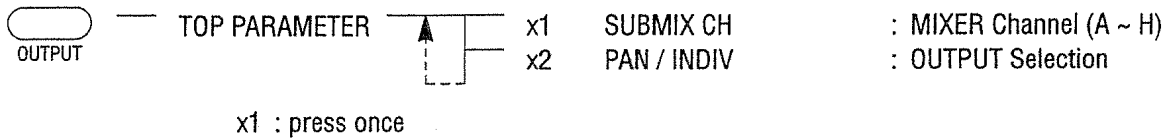

1. OUTPUT Patch Configuration

While the XD-5 has no EFFECTS, it is equipped with six independent OUTPUT jacks as well as left and right Stereo jacks. The OUTPUT Patch is where data on how SINGLE Patches and KIT Patches are connected to these eight output jacks is stored.

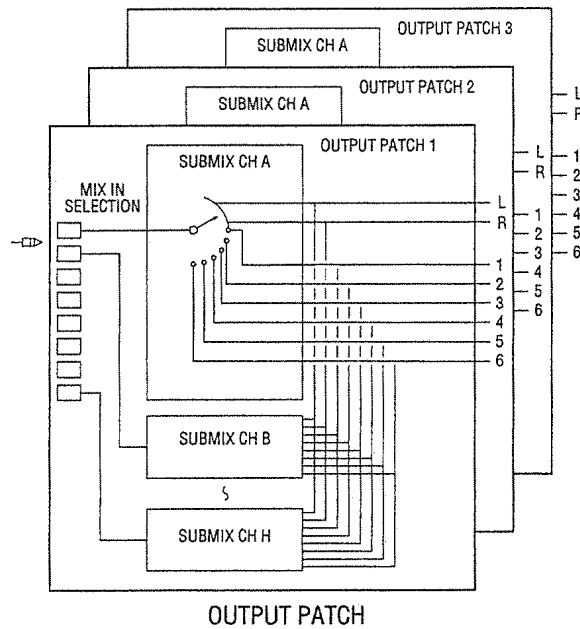

Note: By using headphones, you can monitor the sound of the right and left outputs, although the Individual Outputs (1-6) can not be heard. With VOLUME Slider, you can control the output level of the R/MONO & L and PHONES outputs. The Individual Outputs are not affected.

2. Editing Parameters

● SUBMIX CH

(Value: A ~ H)

Select the SUBMIX CH to be edited.

<Procedure>

```
OUTPUT PACH 16
SUBMIX EDIT=H/I6
```

- (1) Press the several times to display the SUBMIX CH Select screen.
- (2) Select with the VALUE Slider or the and .
- (3) Repeat steps (1) and (2), if you want to edit other SUBMIX CHs.

● PAN/INDIV

(Value: -7 (Right) ~ 0 (Center) ~ +7 (Left), INDIV 1 ~ INDIV 6)

Note: Determine the sound image orientation of the tone using the SUBMIX CH.

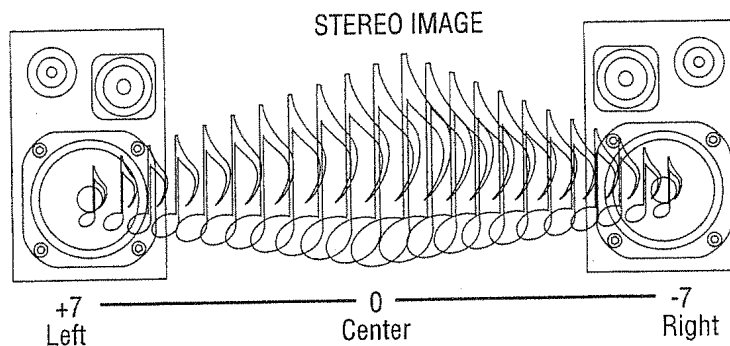

OUTPUT EDIT

<Procedure>

```
OUTPUT PACH H
PAN/INDIV =+ 7
```

- (1) Press the several times to display the PAN Setting screen.
- (2) Make the setting with the VALUE Slider or the and .

3. Writing a OUTPUT Patch

<Procedure>

Note: Make sure that the PROTECT is OFF, and perform the following procedure.

```
OUTPUT WRITE
TO           =I 1
```

```
OUTPUT WRITE I 1
EXEC?= Y/N
```

```
OUTPUT WRITE I 1
SURE?= Y/N
```

+YES

```
COMPLETED!
```

-NO

```
CANCELED!
```

- (1) Press the WRITE to display the following screen.
- (2) Select INT (internal) or EXT (card) with the VALUE Slider or +YES and -NO, and then press the WRITE.
- (3) Select the number of the OUTPUT to be written with the VALUE Slider or the +YES and -NO, and then press the WRITE.
- (4) The message "EXEC?" will then appear. Press +YES to execute writing or -NO to cancel.
- (5) If you pressed +YES in step (4), the message "SURE?" will appear to ask you for confirmation. Press +YES to execute writing or -NO to cancel.

Notes: If necessary, set the PROTECT to OFF.
A new card must be formatted before it can be written to. (See P. 12)

2-6. SYSTEM Programming

The technical parameters for SYSTEM programming are shown below.

SYSTEM programming

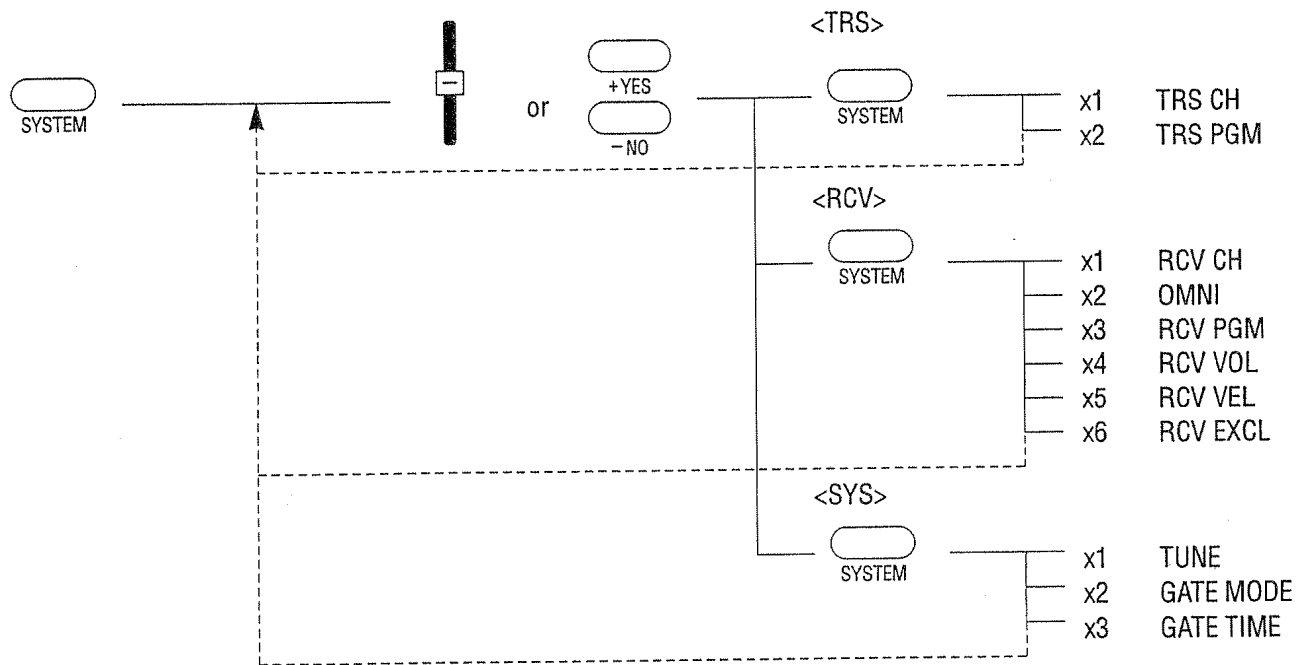

x1 : press once



This sets the values that affect the entire XD-5 unit. These values can be divided broadly into the following three groups.

- TRS (MIDI Transmit)
- RCV (MIDI Receive)
- SYS (SYSTEM)

```
SYSTEM/MIDI
                =TRS
```

<Procedure>

- (1) Press .
- (2) Use the VALUE Slider or and to call up the TRS or RCV or SYS display.
- (3) Press several times to call up the desired parameter.
- (4) Use the VALUE Slider or and to change the value.

1. TRS (TRANSMIT) Group

```
MIDI
TRS CH      = 1
```

```
MIDI
TRS PGM     =ON
```

These are the settings for MIDI Transmission.

- **TRANSMIT CHANNEL (TRS CH)**
(Value: 1~16)
Sets the channel for MIDI Transmission.
- **PROGRAM CHANGE (TRS PGM)**
(Value: ON or OFF)
Selects whether a Program Change is to be transmitted.

2. RCV (RECEIVE) Group

```
MIDI
RCV CH      = 1
```

```
MIDI
OMNI        =ON
```

```
MIDI
RCV PGM     =ON
```

These are the settings for MIDI Reception.

- **RECEIVE CHANNEL (RCV CH)**
(Value: 1~16)
Sets the channel for MIDI Reception.
- **OMNI**
(Value: ON or OFF)
Selects OMNI ON or OFF. If OMNI is On, data on any channel will be received and played when in SINGLE mode.
- **PROGRAM CHANGE (RCV PGM)**
(Value: ON or OFF)
Selects whether a Program Change is to be recognized.
ON : Switches between SINGLE Patches (0 to 63) and KIT Patches (64 to 95).
OFF : All data will be ignored.

SINGLE PATCH (INT/EXT)

	1	2	3	4	5	6	7	8	9	10	11	12	13	14	15	16
A	0	1	2	3	4	5	6	7	8	9	10	11	12	13	14	15
B	16	17	18	19	20	21	22	23	24	25	26	27	28	29	30	31
C	32	33	34	35	36	37	38	39	40	41	42	43	44	45	46	47
D	48	49	50	51	52	53	54	55	56	57	58	59	60	61	62	63

KIT PATCH

	1	2	3	4	5	6	7	8	9	10	11	12	13	14	15	16
INT	64	65	66	67	68	69	70	71	72	73	74	75	76	77	78	79
EXT	80	81	82	83	84	85	86	87	88	89	90	91	92	93	94	95

Notes: SINGLE Patch program change numbers are used for both internal and external memory.

If you want to change from internal to external SINGLE Patch banks (or vice versa), you should select any external (or internal) KIT Patch, then select SINGLE Patch again. Or you should send an EXCLUSIVE Message for XD-5 before sending program change number. The data format of MIDI EXCLUSIVE Message is as See P. 51

This SYSTEM EXCLUSIVE Message is also transmitted when the "SINGLE: INT/EXT" or KIT: INT/EXIT" switches.

MIDI
RCV VOL =ON

● **VOLUME (RCV VOL)**

(Value: ON or OFF)

Selects whether Volume data is to be recognized.

MIDI
RCV VEL =ON

● **VELOCITY (RCV VEL)**

(Value: ON or OFF)

Selects whether Velocity data is to be recognized.

MIDI
RCV EXCL =ON

● **EXCLUSIVE (RCV EXCL)**

(Value: ON or OFF)

Selects whether SYSTEM EXCLUSIVE data is to be recognized.

3. SYS (SYSTEM) Group

```
SYSTEM
TUNE      = 0
```

- **TUNE**

(Value: -50~+50)

TUNE enables fine tuning of the overall pitch of the XD-5, and is used when tuning the synthesizer to other instruments, like a piano.

Note: The pitch tuning of the XD-5 is based on A3=440 Hz and can be raised or lowered up to a maximum of a half tone (100 cents) in increments of 2 cents.

```
SYSTEM
GATE MODE =OFF
```

- **GATE MODE**

(Value: ON or OFF)

This item is normally set to OFF. It should be set to ON when playing the XD-5 using certain MIDI pad controllers or rhythm machines which do not allow control of GATE TIME. When using this setting, be sure to set the GATE TIME item as described below.

```
SYSTEM
GATE TIME = 17
```

- **GATE TIME**

(Value: 1~30)

Use this item to set the gate time to be used when the GATE MODE item (above) is set to ON.

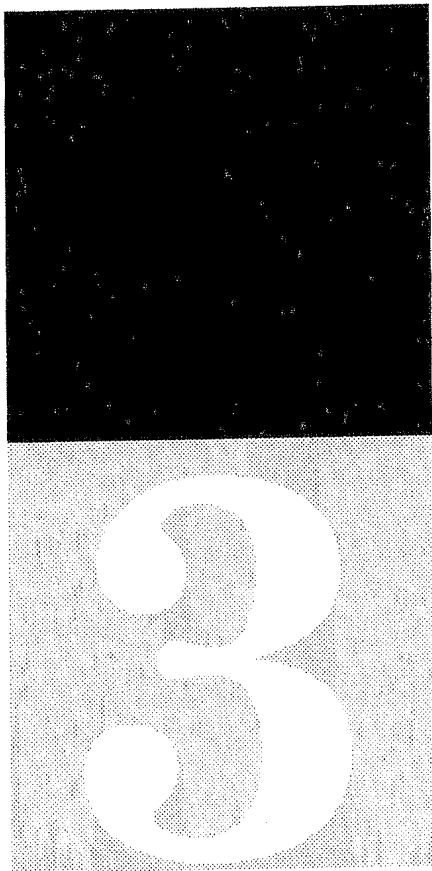

Chapter 3. Advanced Applications

This chapter explains advanced techniques and information for the player and composer when using the XD-5 and MIDI.

3-1. MIDI DATA DUMP

3-2. MIDI for the Advanced User

3-1. MIDI DATA DUMP

The XD-5 can execute MIDI Data Dumps of individual patches, blocks of patches, or the entire patch memory.

Data control is easy when a sequencer with a MIDI Data Dump function such as the Q-80 is used. With the Q-80, data equivalent to about 40 times the storage capacity of the XD-5 can be saved on a 2DD disk.

Parameter	SNGL/KIT	* SGL	* KIT	OUT	* OUT	ALL
Dump Data						ALL
SINGLE	1Patch	64Patch				
KIT	1Patch		16Patch			
OUTPUT				1Patch	16Patch	
Comment	*1	*2	*2	*1	*2	*2

*1 Selected Patch

*2 INT (Internal) or EXT (Card)

Before performing the MIDI Data Dump, select the patches set for the OUTPUT Settings or Patches and Blocks which you wish to transmit.

Example: Transmit KIT Patch #1

<Procedure>

- Choose KIT Patch #1.
- Press several times to display the MIDI Data Dump Select screen. Select "KIT" with the VALUE Slider or and .
- Press once to display the MIDI Data Dump Execute screen.

Note: If necessary, ready the connected instrument for receiving the MIDI Data Dump.

```
KIT
I -1 ACOUSTIC 1
```

```
MIDI
DUMP SELECT=KIT
```

```
DATA DUMP
EXEC?= Y/N
```

```
DATA DUMP
SURE?= Y/N
```

```
COMPLETED!
```

```
CANCELED!
```

- After you press , you will be asked if you are sure – press again to confirm. The message "COMPLETED!" will be displayed when the dump has finished.

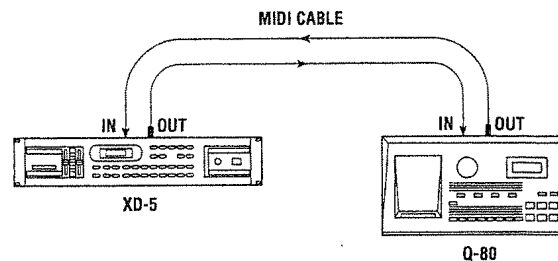

Refer to the "DATA DUMP" command for the Q-80 Owner's Manual for the Q-80.

3-2. MIDI for the Advanced User

● Control Change Messages

Control Change Number	Transmit	Receive	Remarks
7 Volume	X	○	0 ~ 127
100, 101 RPN	○ (1)	○ (1)	Values are given by Data Entry (#6)

● Program Change Messages

SINGLE PATCH (INT/EXT)

	1	2	3	4	5	6	7	8	9	10	11	12	13	14	15	16
A	0	1	2	3	4	5	6	7	8	9	10	11	12	13	14	15
B	16	17	18	19	20	21	22	23	24	25	26	27	28	29	30	31
C	32	33	34	35	36	37	38	39	40	41	42	43	44	45	46	47
D	48	49	50	51	52	53	54	55	56	57	58	59	60	61	62	63

KIT PATCH

	1	2	3	4	5	6	7	8	9	10	11	12	13	14	15	16
INT	64	65	66	67	68	69	70	71	72	73	74	75	76	77	78	79
EXT	80	81	82	83	84	85	86	87	88	89	90	91	92	93	94	95

Notes: These program change numbers are used for both internal and external memory.

If you want to change from internal to external patch banks (or vice versa), you should send an EXCLUSIVE Message for XD-5 before sending program change number.

The data format of MIDI EXCLUSIVE Message is as below:

F0	40	00	30	00	06	00 (INT) or 02(EXT)	00	F7
----	----	----	----	----	----	---------------------	----	----

This SYSTEM EXCLUSIVE is also transmitted when the SINGLE
INT/EXT

or KIT
INT/EXT is pressed.

● System Exclusive Messages

(1) EXCLUSIVE Data Format

Status	F0H	SYSTEM EXCLUSIVE Message
Kawai ID number	40H	
Channel number	0nH	n=0-F
Function number		
Group number	00H	Synthesizer Group
Model ID number	06H	XD-5 ID number
Subcommand 1		
Subcommand 2		
Data		
Data		
EOX		End of EXCLUSIVE

(2) Dump Request

Depending on the type of Dump Request, the values in the following table are substituted for function number, subcommand 1, and subcommand 2 in the EXCLUSIVE Data Format shown in item 1) above.

Dump request type			Function number	Subcommand 1	Subcommand 2
ONE DUMP	SINGLE	INT	00H	00H	00H-3FH
	KIT				40H-4FH
	OUTPUT			01H	00H-FH
	SINGLE	EXT		02H	00H-3FH
	KIT				40H-4FH
	OUTPUT			03H	00H-FH
ALL DUMP	INT		02H	00H	00H
	EXT			02H	00H
ALL SINGLE	INT		01H	00H	00H
	EXT			02H	
ALL KIT	INT		01H	00H	40H
	EXT			02H	
ALL OUTPUT	INT		01H	01H	00H
	EXT			03H	

MIDI RCV INDICATOR

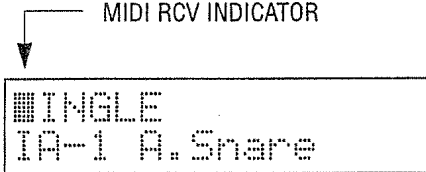

Notes: MIDI RCV INDICATOR

Every time the XD-5 receives MIDI data, the sign appears at the upper left corner.

APPENDICES

A-1. Error Messages

An error message will be displayed if an operation is incorrect or contains some error. If an error message appears, check this section and take action as explained to correct the problem.

Messages Appearing During WRITE or SAVE/LOAD Operations

Message	Cause	Response
PROTECTED!	The WRITE PROTECT parameter for the destination (internal memory or card) is ON.	Turn off WRITE PROTECT for the internal memory or card. (See P.13)
NO CARD!	A WRITE, SAVE, or LOAD operation was attempted with the card not inserted.	Insert the card correctly.
ID ERROR!	An attempt was made to select a Patch using a card not formatted for the XD-5.	Use a correct card, or reformat it. (See P.12)
CAN'T WRITE!	An attempt was made to SAVE data to a ROM card.	Use a RAM card.

Messages Appearing When the Batteries Need Replacing

Message	Cause	Response
CHECK! INTERNAL BATTERY	The backup battery for the XD-5 is almost dead.	Contact your Kawai Service Center.

A-2. Troubleshooting

Since the XD-5 is equipped with a wide variety of functions, depending on the settings, it may not operate as expected. Also, sound may not be output due to connected amplifiers or other equipment. This chart explains troubleshooting for these types of problems.

Problem	Possible cause	Page to see
No sound	Is the VOLUME too low? Adjust the VOLUME on the XD-5 or any connected amplifiers or other equipment.	P.2
	Can sound be heard through headphones when connected? If sound is heard, the problem cause may be with connected equipment or cords. Check connections.	P2, 8
	Is the volume level for the XD-5 too low because of MIDI volume data from external MIDI equipment? After lowering the volume on the amplifier or other connected equipment, turn the power off and then on again.	P. 47
Sound is distorted	Is the connection to the amplifier's IN jack secure?	P. 8
MIDI data cannot be transmitted or received correctly.	Are the MIDI functions for the transmitting and receiving equipment set correctly? When MIDI data is received by the XD-5, the first character of the LCD will flash momentarily.	P. 46, 47

SINGLE PATCH	VOLUME						
	OUTPUT PATCH						
	SUBMIX CH						
	NAME						
	COMMON	SOURCE MODE					
		AM					
		POLY MODE					
	AUTO BEND	TIME					
		DEPTH					
		VEL DEPTH					
				S1	S2	S3	S4
	S-COMMON	DELAY					
		VEL CURVE					
	DCO	WAVE					
		KEY TRACK					
		COARSE					
		FINE					
		FIXED KEY					
		AUTO BEND					
	DCA	LEVEL					
		ATTACK					
		DECAY					
		SUSTAIN					
		RELEASE					
	DCA MOD	VEL DEPTH					
		DECAY MOD VEL					
				F1		F2	
	DCF	CUT OFF					
		RESONANCE					
		VEL DEPTH					
DCF MOD	ENV DEPTH						
	VEL DEPTH						
	ATTACK						
	DECAY						
	SUSTAIN						
	RELEASE						
	DECAY MOD VEL						

OUTPUT PATCH	SUBMIX CH	A	B	C	D	E	F	G	H
	PAN/INDIV								

OPTION DATA

INDEX

A		E	
AM	26, 29	EDIT KEY	18
ATTACK (DCA)	34	EDIT KIT	15
ATTACK (DCF-MOD)	39	EDIT OUTPUT	42
AUTO BEND DEPTH	31	EDIT SINGLE	23
AUTO BEND SW	33	ENV DEPTH (DCF-MOD)	38
AUTO BEND TIME	31	ENVELOPE (DCA)	34
AUTO BEND VEL DEPTH	31	ENVELOPE (DCF-MOD)	39
		ERROR MESSAGES	53
B		EXT	9, 10
BLANK CHART	55		
		F	
C		FILTER	37
CARD	1, 12	FILTER COPY	40
COARSE	33	FINE	33
COMMON	29	FIXED KEY	33
COMPARE	14	FORMAT (CARD)	12
CONFIGURATION OF KIT	16		
CONFIGURATION OF OUTPUT	42	G	
CONFIGURATION OF SINGLE	24	GATE MODE	48
COPY FILTER	40	GATE TIME	48
COPY KIT	21		
COPY SOURCE	40	H	
CUTOFF	37	HEADPHONES	2, 42
D		I	
DATA DUMP	50	INDIVIDUAL OUT	1, 42
DC (DIGITAL CYCLIC)	26	INT	9, 10
DCA	34		
DCA-MOD	35	K	
DCF	37	KEY TRACK	33
DCF-MOD	38	KIT COPY	21
DCO	33	KIT PLAY	9
DECAY (DCA)	34	KIT EDIT	15
DECAY (DCF-MOD)	39		
DECAY MOD VEL(DCA-MOD)	36	L	
DECAY MOD VEL(DCF-MOD)	39	LEVEL (DCA)	34
DELAY (S-COMMON)	32	LEVEL (KIT EDIT)	20
DOUBLE	29	LOAD FROM CARD	13
DUMP	50		
DUMP REQUEST	52	M	
		MIDI DATA DUMP	50
		MIDI EXCLUSIVE ON/OFF	47
		MIDI IMPLEMENTATION CHART	58
		MIDI OMNI	46
		MIDI RCV	46
		MIDI RCV CH	46
		MIDI TRS	46
		MIDI TRS CH	46

N		T	
NAME (KIT)	17	TROUBLE SHOOTING	54
NAME (SINGLE)	28	TUNE (KIT)	19
NORMAL		TUNE (SYSTEM)	48
		TWIN	29
O		V	
OMNI	46	VALUE SET	14
OUTPUT PATCH	42	VEL CURVE	32
		VEL DEPTH (DCA-MOD)	35
P		VEL DEPTH (DCF)	36
PAN (OUTPUT)	43	VEL DEPTH (DCF-MOD)	37
PARA OUT	42	VELOCITY	VEL
PATCH SELECT	9, 10	VOLUME (KIT MODE)	17
PITCH (KIT)	19	VOLUME (SINGLE MODE)	28
PLAY SW	2	VOLUME (UNIT)	2
POLY MODE	30		
PREV (PREVIOUS)	14	W	
PROGRAM CHANGE	46, 47, 51	WAVE	26
PROTECT	13	WRITE KIT	22
		WRITE OUTPUT	44
R		WRITE SINGLE	41
RCV CH	46		
RELEASE (DCA)	34		
RELEASE (DCF-MOD)	39		
RESONANCE	37		
S			
S-COMMON	32		
SAVE TO CARD	13		
SINGLE (KIT EDIT)	18		
SINGLE PLAY	10		
SINGLE EDIT	23		
SOURCE COPY	40		
SOURCE MODE	29		
SOURCE MUTE	27		
SOURCE SELECT	27		
SUBMIX CH	42		
SUBMIX CH (KIT EDIT)	20		
SUBMIX CH (SINGLE EDIT)	28		
SUBMIX CH EDIT (OUTPUT)	43		
SUSTAIN (DCA)	34		
SUSTAIN (DCF-MOD)	39		
SYSTEM RCV	46		
SYSTEM SYS	48		
SYSTEM TRS	46		

Function...		Transmitted	Recognized	Remarks
Basic Channel	Default Changed	1 - 16 1 - 16	1 - 16 1 - 16	Memorized
Mode	Default Messages Altered	- X *****	1, 3 OMNI ON / OFF X	Memorized MONO Ignored
Note Number	True Voice	24 - 108 *****	0 - 127 0 - 127	
Velocity	Note ON Note OFF	X X	* 1 X	
After Touch	Key's Ch's	X X	X X	
Pitch Bend		X	X	
Control Changes	7 100, 101 6	X * 2 (1) * 2	* 1 * 2 (1) * 2	Volume RPN LSB, MSB Data Entry
Prog Change	True #	* 1 *****	* 1 0 - 95	
System Exclusive		○	* 1	
Common	: Song Pos : Song Sel : Tune	X X X	X X X	
System Real Time	: Clock : Commands	X X	X X	
Aux Messages	: Local ON/OFF : All Notes OFF : Active Sense : Reset	X X ○ X	X ○ (123 ~ 127) ○ X	
Notes		* 1 Can be set to ○ or X Memorized even after turning off the power * 2 PRN #1 = Master fine tuning Values are given by Data Entry		

Mode 1 : OMNI ON, POLY

Mode 2 : OMNI ON, MONO

















○ : Yes

Mode 3 : OMNI OFF, POLY

Mode 4 : OMNI OFF, MONO

X : No

XD-5 Specifications

SOUND SYSTEM	16 Bit PCM & DC WAVES (TOTAL 256 WAVES)
MAX POLYPHONY	NORMAL: 16, TWIN&DOUBLE :8 (32 SOURCES)
PROGRAM MEMORY	INTERNAL: 64 SINGLE, 16 KIT, 16 OUTPUT DC-16 MEMORY CARD: 64 SINGLE, 16 KIT, 16 OUTPUT
KIT EDIT	 VOLUME, OUTPUT PATCH, NAME  EDIT KEY, COPY  SINGLE  PITCH, TUNE  LEVEL
SINGLE EDIT	 VOLUME, OUTPUT PATCH, SUBMIX CH, NAME  SOURCE MODE, AM, POLY MODE  AUTO BEND TIME/DEPTH/VEL DEPTH  DELAY, VEL CURVE, COPY  WAVE, KEY TRACK, COARSE, FINE, FIXED KEY, A. BEND on/off,  LEVEL, ATTACK, DECAY, SUSTAIN, RELEASE  VEL DEPTH, DECAY MOD VEL  CUTOFF, RESONANCE, VEL DEPTH  ENV DEPTH, VEL DEPTH, ATTACK, DECAY, SUSTAIN, RELEASE, DECAY MOD VEL
OUTPUT EDIT	 SUBMIX CH, PAN/INDIV
SYSTEM	 TRS: CHANNEL, PGM RCV: CHANNEL, OMNI, PGM, VOL, VEL, EXCLUSIVE SYS: TUNE, GATE MODE/TIME
WRITE	 WRITE, DATA DUMP, INT PROTECT, CARD PROTECT, SAVE/LOAD, CARD FORMAT
FRONT AND REAR PANEL CONTROLS & jacks	CARD SLOT, VOLUME SLIDER, VALUE SLIDER, OPERATION SWITCHES, PHONES jack, POWER SW, DC IN, OUTPUT STEREO L/R (MONO) + 1 ~ 6 INDIVIDUAL, MIDI IN/OUT/THRU
DISPLAY	16 x 2 LCD backlit
DIMENSIONS (mm)	483 (W) x 218.5 (D) x 88 (H) (19-1/8" x 8-1/4" x 3-1/2")
WEIGHT	2.8 kg (6.2 lbs)

1000

1000

1000

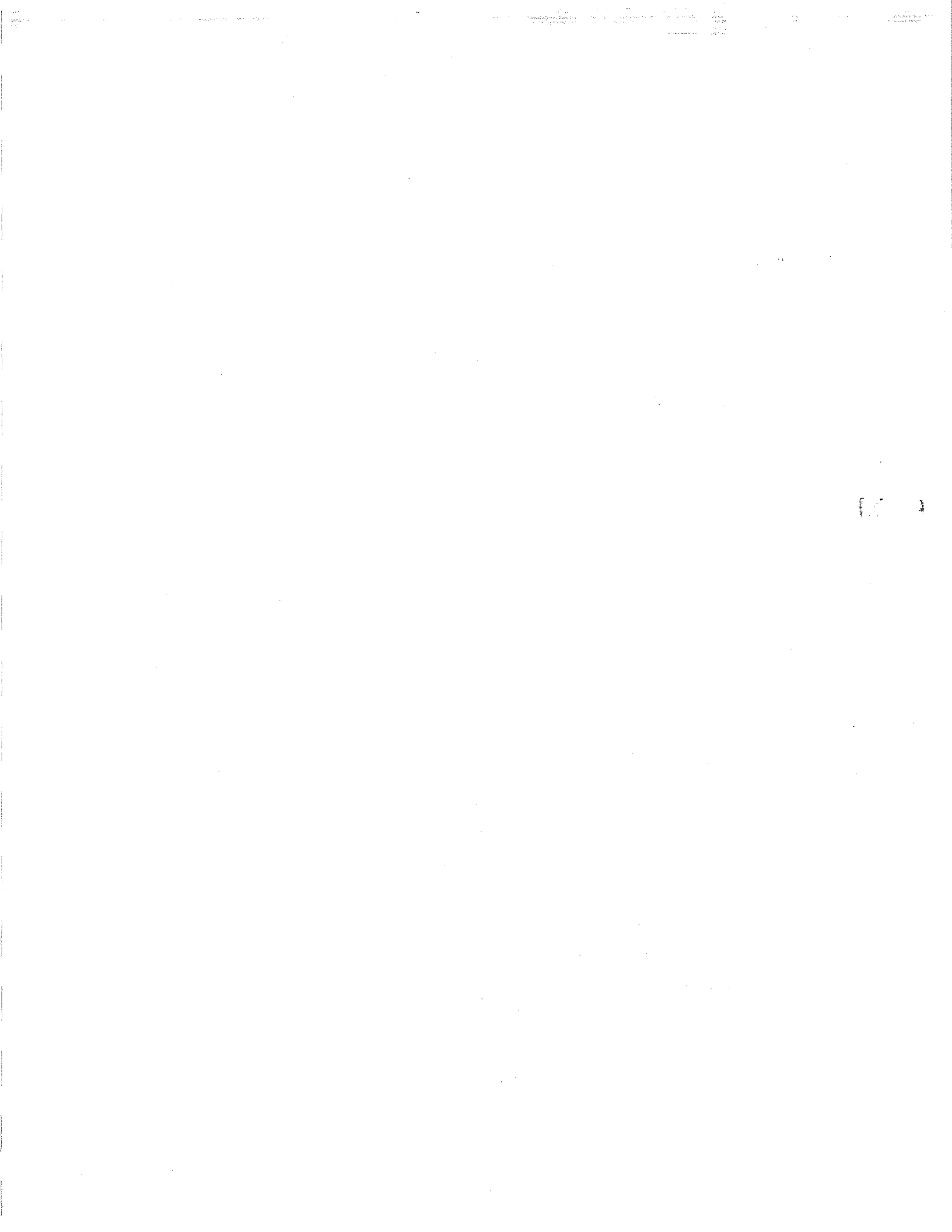

Em: Shinethru2u@LYCOS.COM

KAWAI

Kawai Musical Instruments Manufacturing Co., Ltd.
200 Terajima-cho, Hamamatsu, Japan